



**THDP0100/0200 & TMDP0200
High Voltage Differential Probes
Instruction Manual**



077-0540-02



**THDP0100/0200 & TMDP0200
High Voltage Differential Probes
Instruction Manual**

Copyright © Tektronix. All rights reserved. Licensed software products are owned by Tektronix or its subsidiaries or suppliers, and are protected by national copyright laws and international treaty provisions.

Tektronix products are covered by U.S. and foreign patents, issued and pending. Information in this publication supersedes that in all previously published material. Specifications and price change privileges reserved.

TEKTRONIX and TEK are registered trademarks of Tektronix, Inc.

Contacting Tektronix

Tektronix, Inc.
14150 SW Karl Braun Drive
P.O. Box 500
Beaverton, OR 97077
USA

For product information, sales, service, and technical support:

- In North America, call 1-800-833-9200.
- Worldwide, visit www.tek.com to find contacts in your area.

Warranty

Tektronix warrants that this product will be free from defects in materials and workmanship for a period of one (1) year from the date of shipment. If any such product proves defective during this warranty period, Tektronix, at its option, either will repair the defective product without charge for parts and labor, or will provide a replacement in exchange for the defective product. Parts, modules and replacement products used by Tektronix for warranty work may be new or reconditioned to like new performance. All replaced parts, modules and products become the property of Tektronix.

In order to obtain service under this warranty, Customer must notify Tektronix of the defect before the expiration of the warranty period and make suitable arrangements for the performance of service. Customer shall be responsible for packaging and shipping the defective product to the service center designated by Tektronix, with shipping charges prepaid. Tektronix shall pay for the return of the product to Customer if the shipment is to a location within the country in which the Tektronix service center is located. Customer shall be responsible for paying all shipping charges, duties, taxes, and any other charges for products returned to any other locations.

This warranty shall not apply to any defect, failure or damage caused by improper use or improper or inadequate maintenance and care. Tektronix shall not be obligated to furnish service under this warranty a) to repair damage resulting from attempts by personnel other than Tektronix representatives to install, repair or service the product; b) to repair damage resulting from improper use or connection to incompatible equipment; c) to repair any damage or malfunction caused by the use of non-Tektronix supplies; or d) to service a product that has been modified or integrated with other products when the effect of such modification or integration increases the time or difficulty of servicing the product.

THIS WARRANTY IS GIVEN BY TEKTRONIX WITH RESPECT TO THE PRODUCT IN LIEU OF ANY OTHER WARRANTIES, EXPRESS OR IMPLIED. TEKTRONIX AND ITS VENDORS DISCLAIM ANY IMPLIED WARRANTIES OF MERCHANTABILITY OR FITNESS FOR A PARTICULAR PURPOSE. TEKTRONIX' RESPONSIBILITY TO REPAIR OR REPLACE DEFECTIVE PRODUCTS IS THE SOLE AND EXCLUSIVE REMEDY PROVIDED TO THE CUSTOMER FOR BREACH OF THIS WARRANTY. TEKTRONIX AND ITS VENDORS WILL NOT BE LIABLE FOR ANY INDIRECT, SPECIAL, INCIDENTAL, OR CONSEQUENTIAL DAMAGES IRRESPECTIVE OF WHETHER TEKTRONIX OR THE VENDOR HAS ADVANCE NOTICE OF THE POSSIBILITY OF SUCH DAMAGES.

[W2 – 15AUG04]

Table of Contents

Important Safety Information	iii
General Safety Summary	iii
Service Safety Summary	v
Terms in this Manual	v
Symbols and Terms on the Product	v
Compliance Information	vi
Safety Compliance	vi
Environmental Considerations	viii
Preface	ix
Probe Operating Information	1
Connecting to the Instrument	1
Connecting to the Circuit	2
Probe Controls and Indicators	3
Accessories	6
THDP0100 Probe Standard Accessories	6
THDP0200 & TMDP0200 Probe Standard Accessories	10
THDP & TMDP Series Probes Optional Accessories	17
Options	18
Functional Check	19
Operating Basics	22
Operating Characteristics and Probing Techniques	22
Specifications	26
Warranted Specifications	26
Typical Characteristics	27
Mechanical Characteristics	28
Nominal Characteristics	29
Performance Graphs	29
Performance Verification	33
Required Equipment	33
Test Procedures	35
Adjustments	39
Equipment Required	41
Adjustment Procedures	42
Troubleshooting	53
Host Instrument Firmware	53
Error Conditions	53
Cleaning	54
Service	54
Index	

Important Safety Information

This manual contains information and warnings that must be followed by the user for safe operation and to keep the product in a safe condition.

To safely perform service on this product, additional information is provided at the end of this section. (See page v, *Service Safety Summary*.)

General Safety Summary

Use the product only as specified. Review the following safety precautions to avoid injury and prevent damage to this product or any products connected to it. Carefully read all instructions. Retain these instructions for future reference.

This product shall be used in accordance with local and national codes.

For correct and safe operation of the product, it is essential that you follow generally accepted safety procedures in addition to the safety precautions specified in this manual.

The product is designed to be used by trained personnel only.

Only qualified personnel who are aware of the hazards involved should remove the cover for repair, maintenance, or adjustment.

Before use, always check the product with a known source to be sure it is operating correctly.

This product is not intended for detection of hazardous voltages.

Use personal protective equipment to prevent shock and arc blast injury where hazardous live conductors are exposed.

While using this product, you may need to access other parts of a larger system. Read the safety sections of the other component manuals for warnings and cautions related to operating the system.

When incorporating this equipment into a system, the safety of that system is the responsibility of the assembler of the system.

To Avoid Fire or Personal Injury

Connect and Disconnect Properly. Do not connect or disconnect probes or test leads while they are connected to a voltage source.

Use only insulated voltage probes, test leads, and adapters supplied with the product, or indicated by Tektronix to be suitable for the product.

Observe All Terminal Ratings. To avoid fire or shock hazard, observe all ratings and markings on the product. Consult the product manual for further ratings information before making connections to the product. Do not exceed the Measurement Category (CAT) rating and voltage or current rating of the lowest rated individual component of a product, probe, or accessory.

Do not apply a potential to any terminal, including the common terminal, that exceeds the maximum rating of that terminal.

Do Not Operate Without Covers. Do not operate this product with covers or panels removed, or with the case open. Hazardous voltage exposure is possible.

Avoid Exposed Circuitry. Do not touch exposed connections and components when power is present.

Do Not Operate with Suspected Failures. If you suspect that there is damage to this product, have it inspected by qualified service personnel.

Disable the product if it is damaged. Do not use the product if it is damaged or operates incorrectly. If in doubt about safety of the product, turn it off and disconnect the power cord. Clearly mark the product to prevent its further operation.

Before use, inspect voltage probes, test leads, and accessories for mechanical damage and replace when damaged. Do not use probes or test leads if they are damaged, if there is exposed metal, or if a wear indicator shows.

Examine the exterior of the product before you use it. Look for cracks or missing pieces.

Use only specified replacement parts.

Do Not Operate in Wet/damp Conditions. Be aware that condensation may occur if a unit is moved from a cold to a warm environment.

Do Not Operate in an Explosive Atmosphere.

Keep Product Surfaces Clean and Dry. Remove the input signals before you clean the product.

Probes and Test Leads

Before connecting probes or test leads, connect the power cord from the power connector to a properly grounded power outlet.

Keep fingers behind the protective barrier, protective finger guard, or tactile indicator on the probes.

Remove all probes, test leads and accessories that are not in use.

Use only correct Measurement Category (CAT), voltage, temperature, altitude, and amperage rated probes, test leads, and adapters for any measurement.

Beware of High Voltages. Understand the voltage ratings for the probe you are using and do not exceed those ratings. The following rating is important to know and understand:

- The maximum measurement voltage for the probe tip.

The voltage rating depends on the probe and your application. Refer to the Specifications section of the manual for more information.



WARNING. To prevent electrical shock, do not exceed the maximum measurement or maximum floating voltage for the oscilloscope input BNC connector, probe tip, or probe reference lead.

To prevent damage to the alligator clip insulation, do not use in high A/m magnetic fields at high frequencies, which can cause induction heating of the jaws.

Connect and Disconnect Properly. Connect the probe output to the measurement product before connecting the probe to the circuit under test. Disconnect the probe input from the circuit under test before disconnecting the probe from the measurement product.

Inspect the Probe and Accessories. Before each use, inspect probe and accessories for damage (cuts, tears, or defects in the probe body, accessories, or cable jacket). Do not use if damaged.

Service Safety Summary

The *Service safety summary* section contains additional information required to safely perform service on the product. Only qualified personnel should perform service procedures. Read this *Service safety summary* and the *General safety summary* before performing any service procedures.

To Avoid Electric Shock. Do not touch exposed connections.

Do Not Service Alone. Do not perform internal service or adjustments of this product unless another person capable of rendering first aid and resuscitation is present.

Disconnect Power. To avoid electric shock, switch off the product power and disconnect the power cord from the mains power before removing any covers or panels, or opening the case for servicing.

Use Care When Servicing with Power On. Dangerous voltages or currents may exist in this product. Disconnect power, remove battery (if applicable), and disconnect test leads before removing protective panels, soldering, or replacing components.

Verify Safety After Repair. Always recheck ground continuity and mains dielectric strength after performing a repair.

Terms in this Manual

These terms may appear in this manual:



WARNING. Warning statements identify conditions or practices that could result in injury or loss of life.



CAUTION. Caution statements identify conditions or practices that could result in damage to this product or other property.

Symbols and Terms on the Product

These terms may appear on the product:

- DANGER indicates an injury hazard immediately accessible as you read the marking.
- WARNING indicates an injury hazard not immediately accessible as you read the marking.
- CAUTION indicates a hazard to property including the product.



When this symbol is marked on the product, be sure to consult the manual to find out the nature of the potential hazards and any actions which have to be taken to avoid them. (This symbol may also be used to refer the user to ratings in the manual.)

The following symbol(s) may appear on the product:



Compliance Information

This section lists the safety and environmental standards with which the instrument complies. This product is intended for use by professionals and trained personnel only; it is not designed for use in households or by children.

Questions about the following compliance information may be directed to the following address:

Tektronix, Inc.
PO Box 500, MS 19-045
Beaverton, OR 97077, USA
www.tek.com

Safety Compliance

This section lists the safety standards with which the product complies and other safety compliance information.

EU Low Voltage Directive

Compliance was demonstrated to the following specification as listed in the Official Journal of the European Union:

Low Voltage Directive 2014/35/EU.

- EN 61010-031. Particular requirements for handheld probe assemblies for electrical measurement and test equipment.

U.S. Nationally Recognized Resting Laboratory Listing

- UL 61010-031. Particular requirements for handheld probe assemblies for electrical measurement and test equipment.

Canadian Certification

- CAN/CSA-C22.2 No. 61010-031. Particular requirements for handheld probe assemblies for electrical measurement and test equipment.

Additional Compliances

- IEC 61010-031. Particular requirements for handheld probe assemblies for electrical measurement and test equipment.

Equipment Type

Test and measuring equipment.

Pollution Degree Descriptions

A measure of the contaminants that could occur in the environment around and within a product. Typically the internal environment inside a product is considered to be the same as the external. Products should be used only in the environment for which they are rated.

- Pollution degree 1. No pollution or only dry, nonconductive pollution occurs. Products in this category are generally encapsulated, hermetically sealed, or located in clean rooms.
- Pollution degree 2. Normally only dry, nonconductive pollution occurs. Occasionally a temporary conductivity that is caused by condensation must be expected. This location is a typical office/home environment. Temporary condensation occurs only when the product is out of service.
- Pollution degree 3. Conductive pollution, or dry, nonconductive pollution that becomes conductive due to condensation. These are sheltered locations where neither temperature nor humidity is controlled. The area is protected from direct sunshine, rain, or direct wind.
- Pollution degree 4. Pollution that generates persistent conductivity through conductive dust, rain, or snow. Typical outdoor locations.

Pollution Degree Rating

Pollution degree 2 (as defined in IEC 61010-1). Rated for indoor, dry location use only.

IP rating

IP20 (as defined in IEC 60529).

Measurement and Overvoltage Category Descriptions

Measurement terminals on this product may be rated for measuring mains voltages from one or more of the following categories (see specific ratings marked on the product and in the manual).

- Category II. Circuits directly connected to the building wiring at utilization points (socket outlets and similar points).
- Category III. In the building wiring and distribution system.
- Category IV. At the source of the electrical supply to the building.

NOTE. Only mains power supply circuits have an overvoltage category rating. Only measurement circuits have a measurement category rating. Other circuits within the product do not have either rating.

Mains Overvoltage Category Rating

Overvoltage category II (as defined in IEC 61010-1).

Environmental Considerations

This section provides information about the environmental impact of the product.

Restriction of Hazardous Substances

Complies with RoHS2 Directive 2011/65/EU.

Product End-of-Life Handling

Observe the following guidelines when recycling an instrument or component:

Equipment Recycling. Production of this equipment required the extraction and use of natural resources. The equipment may contain substances that could be harmful to the environment or human health if improperly handled at the product's end of life. To avoid release of such substances into the environment and to reduce the use of natural resources, we encourage you to recycle this product in an appropriate system that will ensure that most of the materials are reused or recycled appropriately.



This symbol indicates that this product complies with the applicable European Union requirements according to Directives 2012/19/EU and 2006/66/EC on waste electrical and electronic equipment (WEEE) and batteries. For information about recycling options, check the Tektronix Web site (www.tek.com/productrecycling).

Preface

This document provides operating information and specifications for the Tektronix THDP0100/0200 & TMDP0200 high voltage differential probes. The probes share similar functions, properties, and operating procedures, and are discussed first, followed by the specifications, which differ by probe model. Service procedures include performance verification and adjustments.



WARNING. Only use the accessories that are designed for your probe and that are rated at or above the voltages you are measuring.

Name	Bandwidth	Peak voltage range	Oscilloscope interface
THDP0100	100 MHz	600 V/6000 V	TekVPI
THDP0200	200 MHz	150 V/1500 V	TekVPI
TMDP0200	200 MHz	75 V/750 V	TekVPI

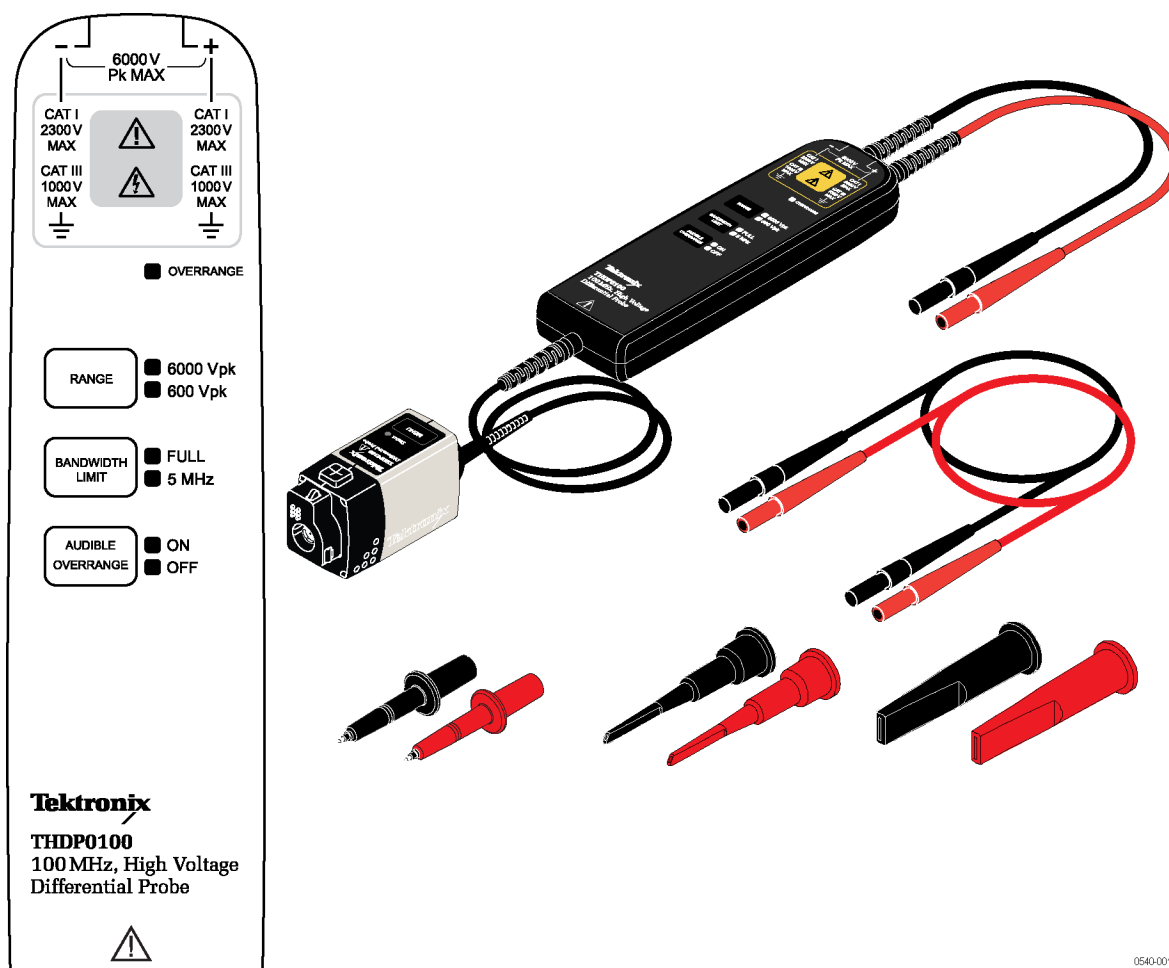

Figure i: THDP0100 probe with accessories

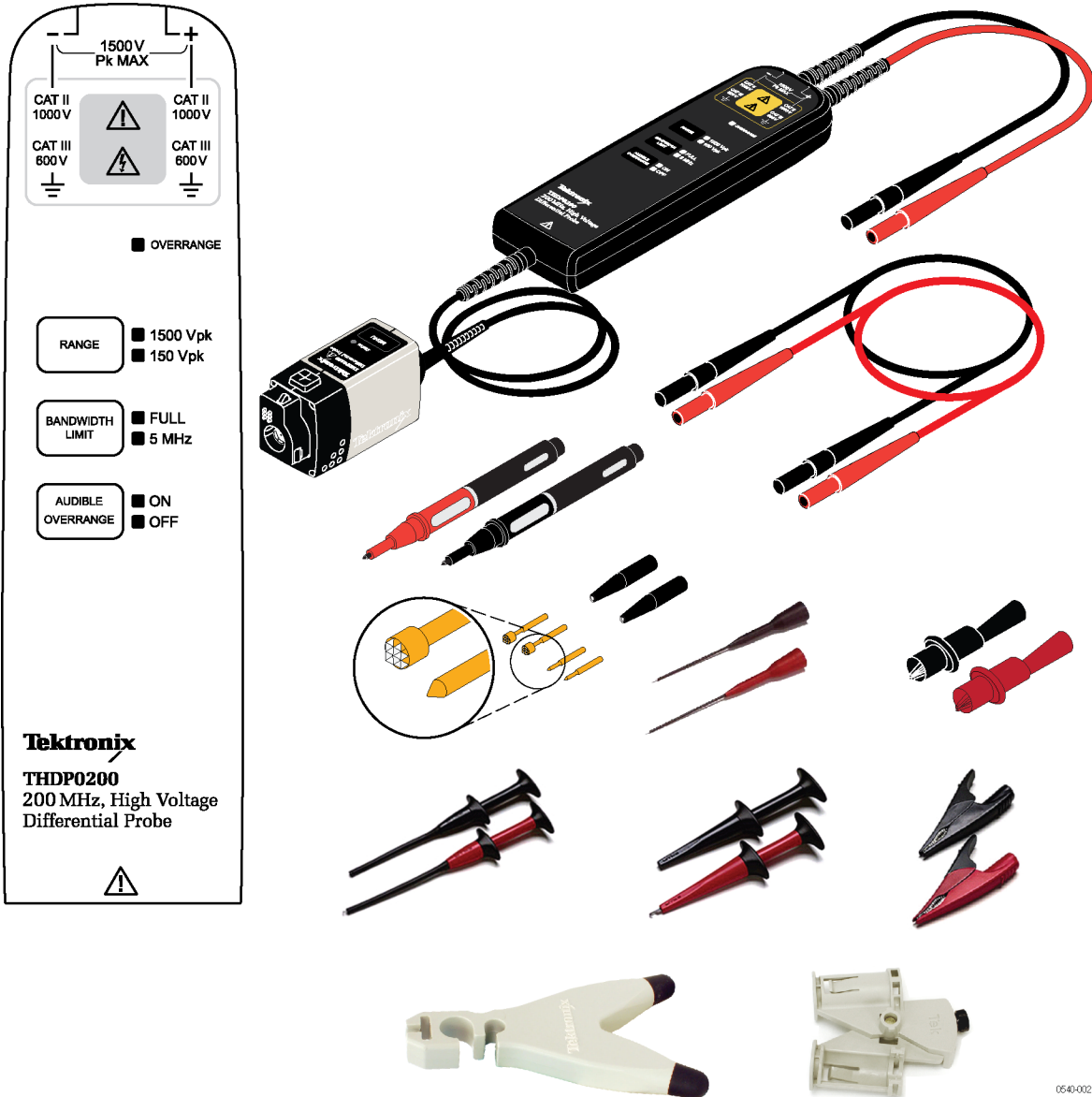

Figure ii: THDP0200 probe with accessories



0540-003

Figure iii: TMDP0200 probe with accessories

Probe Operating Information

This section of the manual describes how to make connections to the instrument and to your circuit, followed by descriptions of the probe controls and indicators.

Connecting to the Instrument

1. Connect the probe to the input of the oscilloscope.
 - All of the LEDs on the probe body briefly light, and then indicate the settings from the previous session.
 - The Status LED on the probe control box lights amber as the probe completes a self-test.
 - The Status LED goes off briefly and then lights green to indicate the probe is ready to use.

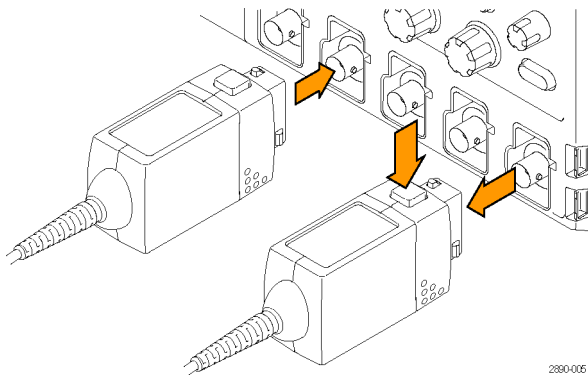

2. Adjust the vertical offset (or position) of the oscilloscope input.
3. Select the proper range setting.

For example, when using the THDP0200 probe, to achieve higher resolution and less noise when measuring signals below 150 V_{pk}, switch the RANGE to 150 V. If the OVERRANGE indicator lights or flashes, the output signal may not be accurate. Use the 1500 V range setting instead.



WARNING. To avoid electrical shock, observe proper safety precautions when working with voltages above 60 VDC or 30 VAC_{RMS}. These voltage levels pose a shock hazard. Use only the accessories specified with the probe that you are using. Make sure that the accessories are fully mated before connecting or disconnecting.

To avoid electrical shock or fire, make sure the test leads are in good condition. The input leads and extender leads have a jacket wear indicator which becomes visible if the wire jacket becomes excessively worn. If the wear indicator is visible, do not use the probe. Contact Tektronix Service for repair or replacement.

To avoid electrical shock or fire, keep the probe body and output cable of the probe away from the circuits being measured. The probe body and output cable are not intended to be in contact with the circuits being measured.

4. Use the probe accessories to connect the probe inputs to the circuit points to be measured. (See page 6, Accessories.)

Connecting to the Circuit

Make the connections to your circuit using the integral input leads or the accessories that best fit your application. The integral input leads extend 10 in (25 cm) from the probe body. Connect the leads directly to your circuit, or use the extender leads and the accessories that are included with the probe. (See page 6, *Accessories*.)

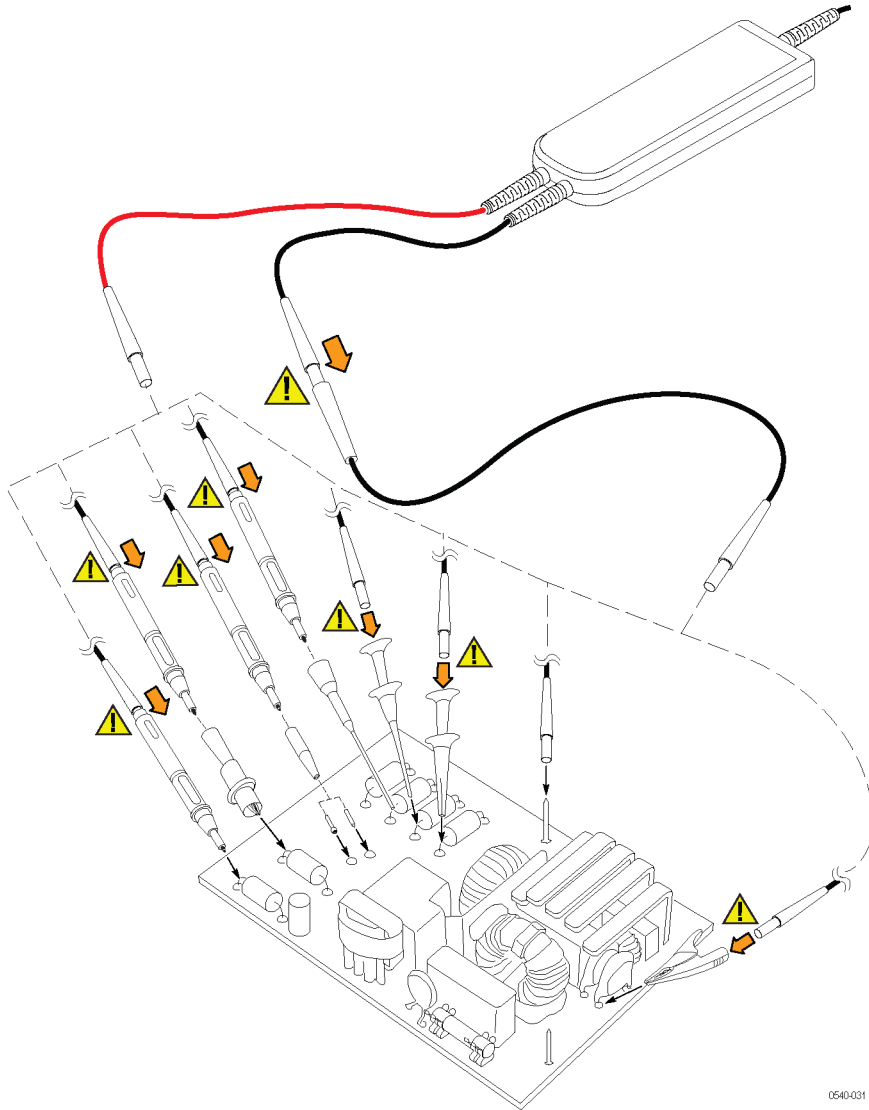

0540-031



WARNING. To avoid electrical shock or fire, always make the connections from the test leads to the probe accessory that you intend to use before you make any connections to a voltage source. Always ensure that the connections between the test leads and the probe accessories are secure before you connect them to a voltage source. Do not connect or disconnect accessories or extended test leads to a voltage source unless they are first connected to the probe.

Probe Controls and Indicators

The probes have several features that make probing and measurement a simpler task. Familiarize yourself with the controls and indicators shown on the following pages. Some features differ from those illustrated, such as probe input voltage limit and voltage range, depending on the probe model.

The probe release button, Status LED, and MENU buttons are located on the probe control box.

Probe Release Button

Press the release button to unlatch the probe from the instrument, and then pull the probe straight out.



WARNING. To avoid electrical shock, disconnect the probe inputs from the circuit before disconnecting the probe from the instrument.

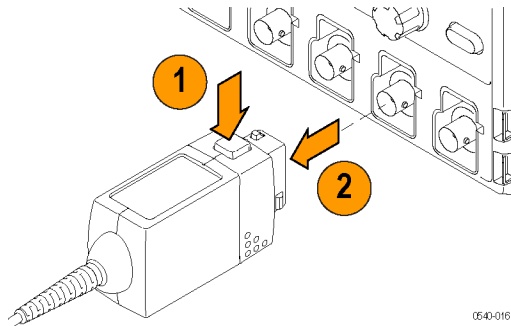

Status LED

When the probe is connected to the instrument, the Status LED lights amber as the probe completes a self-test. Then, the Status LED goes off briefly and then lights green to indicate the probe is ready to use.

The Status LED lights amber or red if the power-on test failed, or any time an error occurs. If the Status LED light does not light green after the self-test, first disconnect the probe from the circuit under test, and then disconnect the probe from the oscilloscope.

Reconnect the probe to the oscilloscope and check that the Status LED lights amber, and then green. If the Status LED continues to light amber or red, there may be other remedies. (See page 53, *Error Conditions*.)

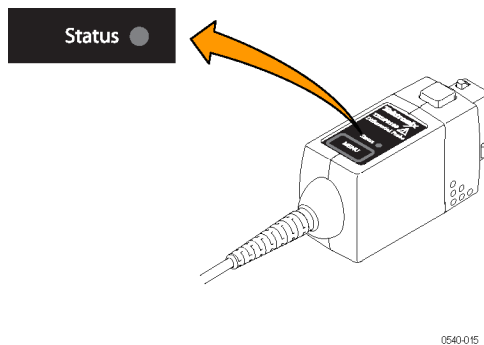

Menu Button

Press the MENU button to display on-screen probe controls on the oscilloscope. Many probe functions are available, such as AutoZero and range selection.

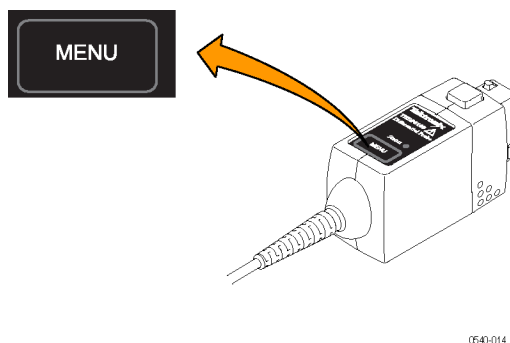

The remaining controls and features of the probe are located on the probe head.

Probe Inputs

The maximum voltage that the probe inputs can accept depend on the probe model and the measurement points.

For example, the THDP0200 probe (shown) can measure a maximum of 1,000 V_{RMS} CAT II between either input and ground, and a maximum difference of 1,500 V (DC + peak AC) between the (-) and (+) inputs. These input ratings are valid for both range settings.

The other probes covered in this manual have different limits; refer to *Specifications*. (See Table 6 on page 27.)

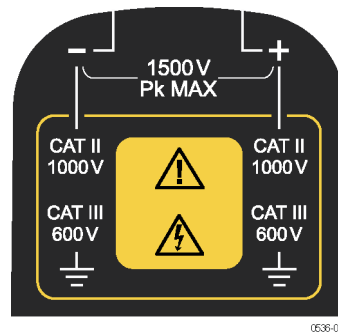

CAUTION. Do not use these probes above the input limits shown on the probes. The input voltage limits vary by probe model.

Overrange Indicator

The OVERRANGE indicator lights red if the voltage of the input differential signal exceeds the linear range of the range setting. When this happens, the signal on the probe output does not accurately represent the signal on the probe input.



WARNING. The Overage indicator does not detect overrange condition of common-mode voltages or voltage-to-earth potential at the probe inputs. The Overage indicator only detects differentially between the + and - inputs (not relative to ground).

Do not exceed the common-mode voltage or input voltage-to-earth ratings of the probe when taking measurements. (See page 25, *Overrange Detection*.)

If you are not sure, make a single-ended measurement of each point you are intending to measure differentially first. Make a single-ended measurement by tying one input lead to ground (the "-" input) and then connecting the other lead (the "+" input) to the points of interest, one at a time.

Voltage Range Button and Indicators

Press the RANGE button to select between the voltage range (attenuation) settings of the probe. The voltage range is indicated by two LEDs on the probe and may be displayed on the oscilloscope screen, depending on the oscilloscope model.

The OVERRANGE LED lights if the applied voltage exceeds the selected range. To extinguish the LED, select a higher range. If a higher range is not available, do not attempt to take the measurement with the probe.

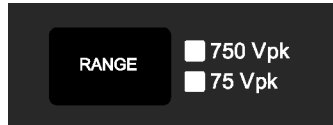

0540-020

Bandwidth Limit Button and Indicators

Press the BANDWIDTH LIMIT button to limit the probe bandwidth to 5 MHz. 5 MHz is close to the switching frequency of most switching transistors (FETs) in switch mode power supplies (SMPS).

The 5 MHz filter assists in the characterization and testing of power supplies in switch mode by removing all high frequency content, noise and harmonics from the measurement.

Press the button again to return to the FULL position, which selects the full specified bandwidth of the probe.

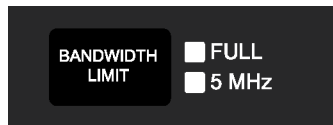

0540-021

Audible Overrange On/Off Button and Indicators

The audible overrange is an audible alarm that indicates when the measured signal exceeds the selected range. The alarm is enabled when the probe is first powered on.

Press the AUDIBLE OVERRANGE button to light the OFF LED and disable the feature. To enable the alarm, press the button again to light the ON LED.



0536-005

Accessories

THDP0100 Probe Standard Accessories



WARNING. To avoid risk of electric shock or fire, do not use the THDP0100 test probe or hook tip accessories on CAT III or CAT IV circuits. Refer to the ratings tables in the Accessories section of the manual. (See Table 1 on page 9.)

To avoid risk of electric shock or fire, when using the THDP0100 test probe or hook tip accessories with the THDP0200 and TMDP0200 probes, do not use on circuits above 1000 V.

Use only accessories that are rated for the application. Substitution of other accessories may create a shock or burn hazard. Keep the probe body and accessories clean to reduce the risk of shock due to surface conduction.

Extender Leads

These leads extend the reach of the probes by ~67 in (1.5 m), which allow you to reach connections as far as 3.5 m apart. Be sure to use both extension leads so that the input leads are the same length.

However, with longer lead length, differential noise induced into the input leads is greater. Also, because of the added inductance of the leads, voltage measurements at frequencies above approximately 10 MHz may not be as precise. For best performance, use the 20 MHz or lower-bandwidth filter on your oscilloscope.

The male banana-plug ends connect to the test probes that are included with the probes.

One pair of extender leads are included with the probes.

Maximum ratings:

1000 V CAT III

600 V CAT IV

Reorder Tektronix part number:

196-3523-xx

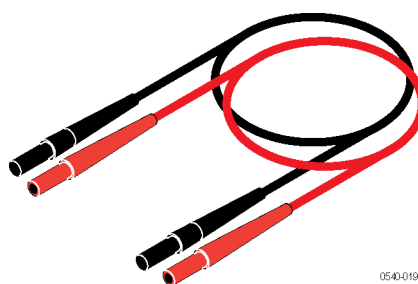

0540-019

THDP0100 Probe Accessory Kit

Kit includes one pair of each of the accessories shown on the following pages:

- Test Probes (TATP)
- Small Hook Tips (TASH)
- Large Hook Tips (TALH)

Reorder Tektronix part number: 020-3070-xx

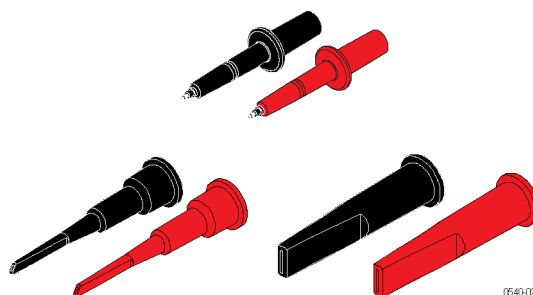

0540-025

Test Probes (TATP)

Use the test probes to browse multiple test points or to connect the test leads to the hook tips.

1. The test probe tip is a 6-32 threaded post that accepts the large and small hook tips provided with the probe.
2. The finger guard provides protection when the hook tips are not being used. Keep your fingers behind the finger guard whenever possible to reduce the risk of a shock from the circuit under test.
3. Connect the back end of the test probe to the input test leads of the probe.

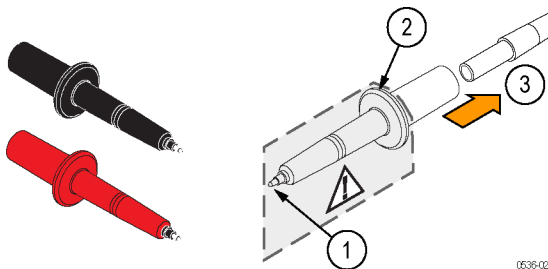

0E36-025

Maximum ratings:

2300 V CAT I*

1000 V CAT II

* See *Specifications* for the Over-Voltage Transient (OVT) rating for the probe that you are using. (See Table 6 on page 27.)



WARNING. To prevent arc flash, use caution when probing circuits with raised components. Avoid getting the metal shell between components of different potentials. Use the small hook tip (TASH) for probing in hard to reach areas.

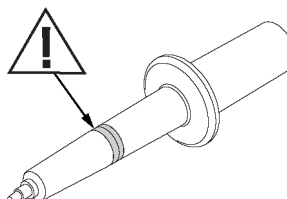

0E36-046



WARNING. To prevent arc flash, do not use the test probe or hook tips on CAT III circuits. To probe CAT III circuits, use the AC280-FL, AC283-FL, or AC285-FL accessories.

Small Hook Tip (TASH)

Use the small hook tip for making connections to small conductors such as component leads.

Screw the small hook tip onto the TATP test probe. To use the hook tip, hold the probe body and pull the tip shield back. Hook the tip onto the circuit and release the shield.



WARNING. To reduce the risk of shock when measuring voltages above 1000 V, always keep your fingers behind the tactile indicator.

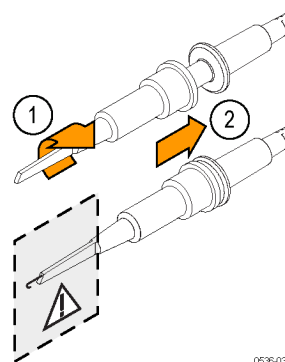
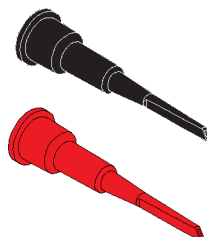

0636-035

Maximum ratings:

2300 V CAT I*

1000 V CAT II

* See *Specifications* for the Over-Voltage Transient (OVT) rating for the probe that you are using. (See Table 6 on page 27.)

Large Hook Tip (TALH)

Use the large hook tip when working with larger components such as bolt terminals and bus bars typically found in power distribution equipment.

Screw the large hook tip onto the TATP test probe and then clamp the hook tip onto the circuit.



WARNING. To reduce the risk of shock when measuring voltages above 1000 V, always keep your fingers behind the tactile indicator.

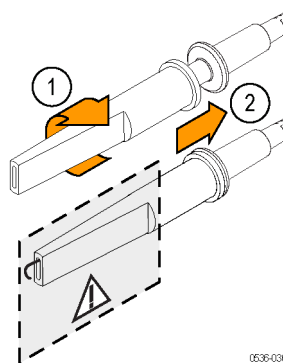
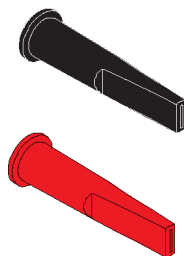

0636-036

Maximum ratings:

2300 V CAT I*

1000 V CAT II

* See *Specifications* for the Over-Voltage Transient (OVT) rating for the probe that you are using. (See Table 6 on page 27.)

Table 1: Voltage derating for THDP0100 probe standard accessories

Accessory (Tektronix part number)	Combined probe and accessory common-mode voltage and input voltage-to-earth ratings		
	THDP0100	THDP0200 ¹	TMDP0200 ¹
Extender leads (196-3523-xx)	2300 V CAT I 1000 V CAT III	1000 V CAT II 600 V CAT III	550 V CAT I 300 V CAT III
Test probe (TATP) (part of 020-3070-xx kit)	1000 V CAT I 1000 V CAT II	1000 V CAT II 600 V CAT II	550 V CAT I 300 V CAT II
Small hook tip (TASH) (part of 020-3070-xx kit)	2300 V CAT I 1000 V CAT II	1000 V CAT II 600 V CAT II	550 V CAT I 300 V CAT II
Large hook tip (TALH) (part of 020-3070-xx kit)	2300 V CAT I 1000 V CAT II	1000 V CAT II 600 V CAT II	550 V CAT I 300 V CAT II

¹ The THDP0200 & TMDP0200 standard accessories can be used with the THDP0100 probe at the reduced voltage levels listed in this table.

Table 2: Voltage derating for THDP0200 & TMDP0200 probe standard accessories

Accessory (Tektronix part number)	Combined probe and accessory common-mode voltage and input voltage-to-earth ratings ^{1 2}		
	THDP0100 ³	THDP0200	TMDP0200
Extender leads (196-3523-xx)	2300 V CAT I 1000 V CAT III	1000 V CAT II 600 V CAT III	550 V CAT I 300 V CAT III
Handheld probes ⁴ (TP175-FL)	1000 V CAT I 1000 V CAT III	1000 V CAT II 600 V CAT III	550 V CAT I 300 V CAT III
Pogo pin tip adapters and tips (020-3107-xx)	150 V CAT II	150 V CAT II	150 V CAT II
Extended test probe adapters (012-1724-xx)	300 V CAT I 300 V CAT II	300 V CAT II	300 V CAT I 300 V CAT II
Hook clips (AC280-FL)	1000 V CAT I 1000 V CAT III	1000 V CAT II 600 V CAT III	550 V CAT I 300 V CAT III
Pincer clips (AC283-FL)	1000 V CAT I 1000 V CAT III	1000 V CAT II 600 V CAT III	550 V CAT I 300 V CAT III
Alligator clips (AC285-FL)	1000 V CAT I 1000 V CAT III	1000 V CAT II 600 V CAT III	550 V CAT I 300 V CAT II
Crocodile clips (344-0670-xx)	300 V CAT I	300 V CAT I	300 V CAT I

¹ The operating altitude of the probe is derated to 2000 m (6560 ft) when used with these accessories.

² The voltage rating and CAT rating are de-rated to the voltage in this table when used with these accessories.

³ The THDP0100 probe can be used with these accessories at the reduced voltage levels listed in this table.

⁴ When using the TP175-FL test probes in CAT III circuits, the tip must be in the retracted position to prevent risk of arc flash. The exposed metal tip is about 3.7 mm (0.15 in) in the retracted position.

THDP0200 & TMDP0200 Probe Standard Accessories

The standard accessories that connect directly to your circuit are shown below, and are described on the following pages.



WARNING. To reduce risk of shock or fire, do not exceed either the voltage rating or category ratings of the probe or the probe accessory, whichever is the lesser of the two. Use only the accessories provided with the probe.

To avoid electric shock when using the probe or accessories, keep your fingers behind the finger guard of the probe body and away from the shaded area shown in the accessory illustrations below.

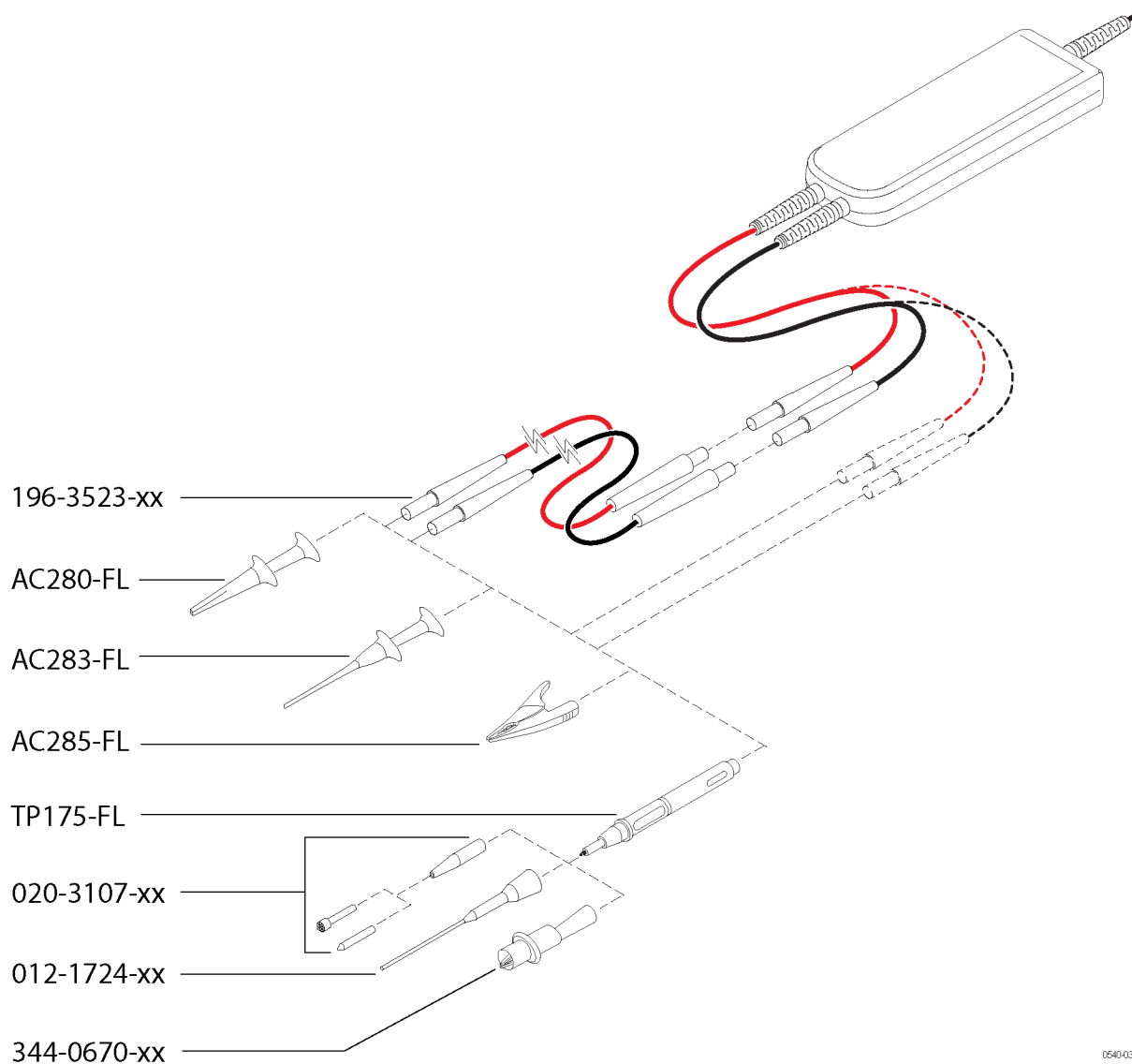

Extender Leads

These cables extend the reach of the probes by ~67 in (1.5 m). The banana ends connect to all of the clip accessories that are included with the probes.

Maximum ratings:

2300 V CAT I *

1000 V CAT III

* See *Specifications* for the Over-Voltage Transient (OVT) rating for the probe that you are using.

One pair of extender leads are included with the probes.

Reorder Tektronix part number:

196-3523-xx (one pair)

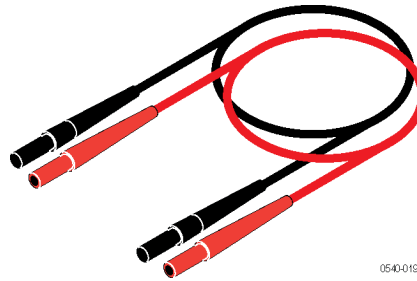

0540-019

Handheld Probes (TP175-FL)

These probes plug onto the banana input leads and extender leads. The tips are threaded to accept tip accessories.

The insulator sheath at the probe tip extends and retracts into CAT III and CAT IV-rated spacings. Twist the probe body past the detent at each end of the twist to lock the probe into the CAT setting.

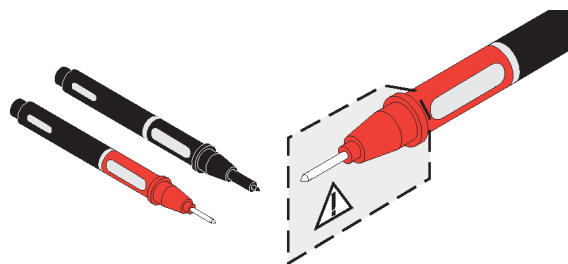

0536-055



WARNING. Always verify that the probe body is locked into position before taking measurements. Do not use in the unlocked neutral position.

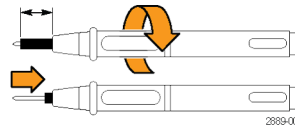

2889-002

Maximum ratings:

1000 V CAT II

1000 V CAT III

10 A

One pair of handheld probes are included with the probes.

Reorder Tektronix part number:

TP175-FL (one pair)

Pogo Pin Tip Adapters & Tips

These insulated adapters hold pogo pins and screw on to the threaded tips of the TP175-FL handheld probes.



WARNING. To prevent electrical shock, tighten the pogo pin tip adapter completely to the TP175-FL probe.

Two pairs of pogo pin types are included with the adapters; one pair have sharp, cone points and the other pair have serrated edges for embedding in soft conductors.



WARNING. The pogo pins have very sharp points. To prevent injury, handle the pins carefully when you install and remove them.



WARNING. To prevent risk of arc flash, ensure that the pogo pin is completely inserted into the adapter. Verify that the exposed metal portion of the tip is 19 mm (0.75 in) or less.



WARNING. The probe input rating is derated to 150 V CAT II, 1 mA, when used with the THDP and TMDP series probes. Do not use this pogo pin adapter to measure voltages that exceed this rating.

Maximum ratings:

150 V CAT II

1 mA

Reorder Tektronix part number:

020-3107-xx (includes 2 Tip Adapters, 2 Cone-Tip Pogo Pins, & 2 Serrated-Tip Pogo Pins)

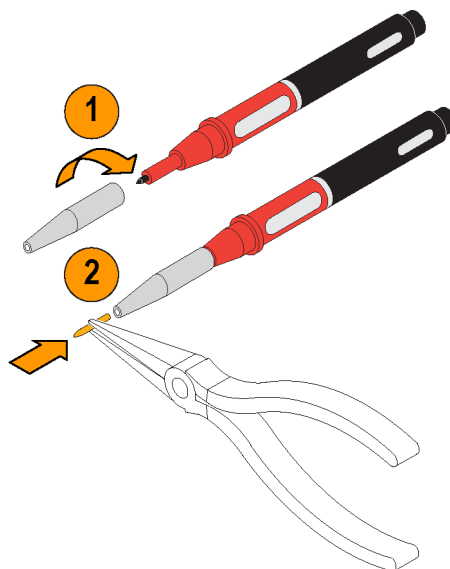

0540-032

Extended Test Probe Adapters

These adapters screw on to the threaded tips of the handheld probes.

Use these adapters to reach into dense circuitry. The sharp tips can contact small component leads and circuit board features.



WARNING. *The probe input rating is derated to 150V CAT II, 1 mA, when used with the THDP and TMDP series probes. Do not use this extended probe adapter to measure voltages that exceed this rating.*



WARNING. *The tip on this adapter is very sharp. To prevent injury, do not touch the tip.*

Maximum ratings:

300 V CAT II

3 A

Reorder Tektronix part number:

012-1724-xx (one pair)

Hook Clips (AC280-FL)

Plug the probe test leads into the banana plug connectors. Squeeze the grips to expose the hook clip and then clasp it around the circuit test point.

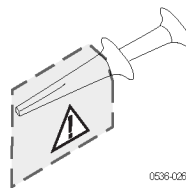

Maximum ratings:

1000 V CAT III

3 A

One pair of hook clips are included with the probes.

Reorder Tektronix part number:

AC280-FL (one pair)

Pincer Clips (AC283-FL)

The plunger probes have long probe sleeves with retracting hooks. These probes safely connect to recessed test points that are otherwise difficult to reach.

Maximum ratings:

1000 V CAT III

1 A

One pair of pincer clips are included with the probes.

Reorder Tektronix part number:

AC283-FL (one pair)

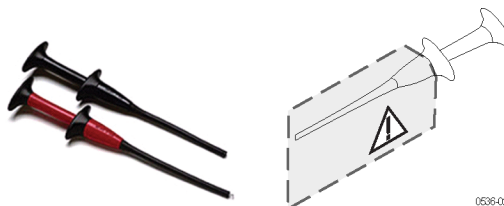

0536-027

Alligator Clips (AC285-FL)

These large insulated alligator clips connect to many circuit components.

Maximum ratings:

1000 V CAT III

10 A

One pair of clips are included with the probes.

Reorder Tektronix part number:

AC285-FL (one pair)



0536-028

Crocodile Clips

The crocodile clips connect easily to large bolts or bus bars. The connectors are double insulated for safety. The clips screw on to the threaded tips of the handheld probes.

Maximum ratings:

1000 V CAT III

10 A

One pair of clips is included with the probes.

Reorder Tektronix part number:

344-0670-xx (one pair)

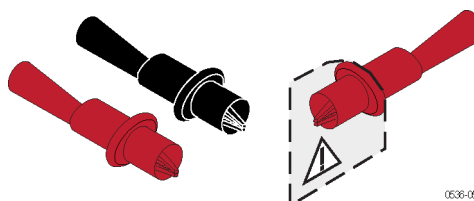

0536-056

TPH1000 Probe Holder

The TPH1000 probe holder allows you to make a hands-free connection when using the handheld probes included in the accessory kit. The probe holder can also be used with many other Tektronix probes.

You have two options for taking hands-free differential measurements:

- You can use the handheld probes with two TPH1000 probe holders (required if the test points are >1 inch apart).
- For test points <1 inch apart, use the handheld probes with the THV-Browser (shown on the following page).



0540-022

To use the probe holder, do the following:

1. Insert the probe into one of the holder openings so that the Tektronix logo faces the circuit under test.
2. Slide the probe forward to secure it.

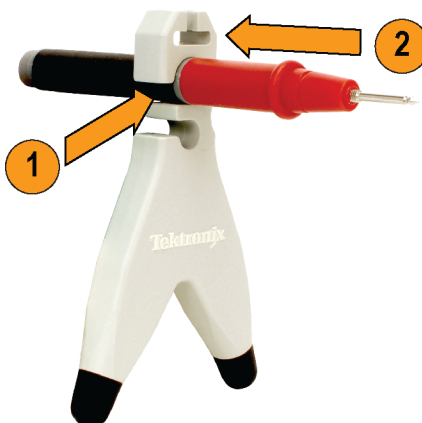

0540-023



CAUTION. To avoid personal injury, always insert and remove probes by gripping the handheld section of the probe.

3. Position the base of the probe holder on your circuit where it can maintain stability while contacting the test point.



WARNING. Do not use the probe holder without the rubber feet; internal metal would be exposed which presents a shock hazard.

The weight of the probe holder keeps the probe in place.



CAUTION. If you are probing circuitry with dense contacts such as IC pins, Tektronix recommends that you use insulated probe tip accessories designed to prevent short-circuiting adjacent IC pins or circuitry.



0592-012

One TPH1000 probe holder is included with the probes.

Reorder Tektronix part number:

TPH1000

THV-Browser

The THV-Browser allows you to set and lock the spacing between two handheld probe tips, and then browse your circuit with one hand.

Handheld Browsing.

1. Place each handheld probe lead into the cavity and then slide the probe forward to secure it.
2. Loosen the thumb screw and adjust the spacing between the probe tips. Graticules near the thumb screw indicate the spacing. The maximum spacing is ~1 in (2.54 mm).
3. Tighten the thumb screw.

You can now browse your circuit.



WARNING. To avoid injury or short circuits, do not drop the THV-Browser on high voltage circuitry. The browser contains metal components.

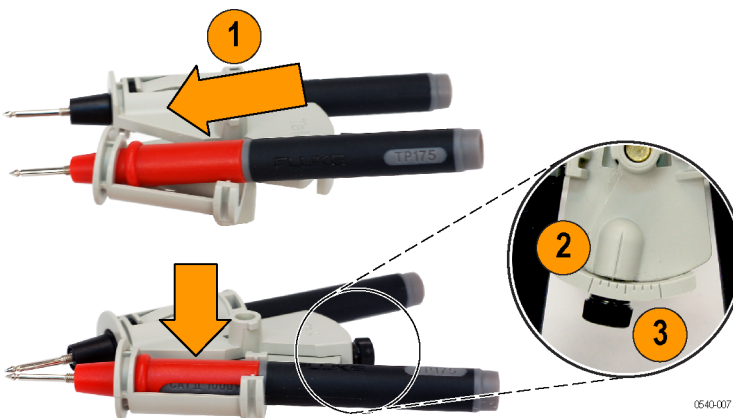
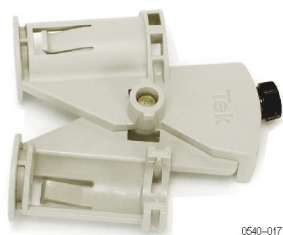

Hands-free Probing.

If you want a stationary, hands-free connection, attach the browser to the TPH1000 probe holder:

4. Align the slots on the top of the probe holder with the pins on the bottom of the browser.
5. Rotate the browser 90°.
6. Position the probe tips on your test points so that you can set the holder on a stable surface.

One THV-Browser is included with the probes.

Reorder Tektronix part number:

THV-Browser

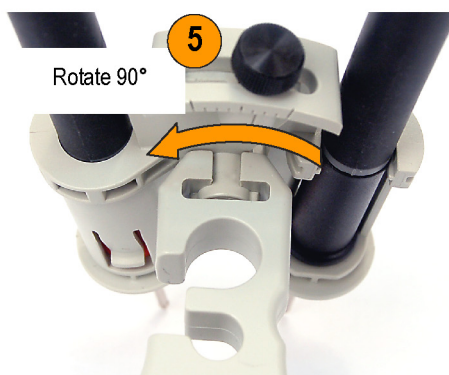
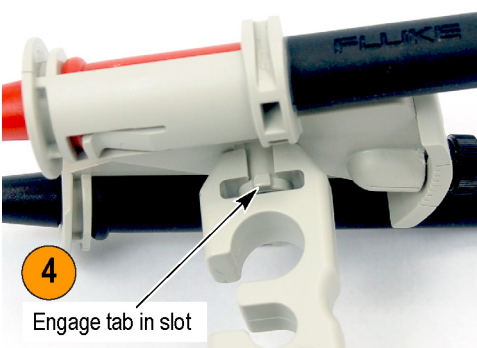

0540-010

THDP & TMDP Series Probes Optional Accessories

TekVPI Calibration Fixture

This calibration fixture is required to complete a performance verification and adjustment procedures on the probe. It provides power to the probe and routes the probe output signal through an SMA connector on the back of the fixture.

The signal can then be measured with another instrument, (for example, a precision DMM), to check and adjust probe qualities such as gain accuracy.

Order Tektronix part number: 067-1701-xx

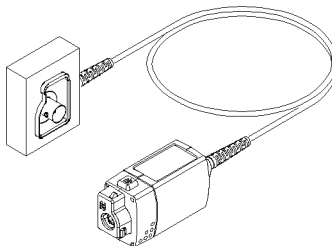

Replacement Label (Safety Item; Service Only)

This reusable label covers the openings to the service-only adjustments on the back of the probe. To maintain the safety of the probe, the label must be replaced after service adjustments are made to the probe.

If the original label becomes damaged or lost, order a replacement label.

Order Tektronix part number:

335-2913-xx

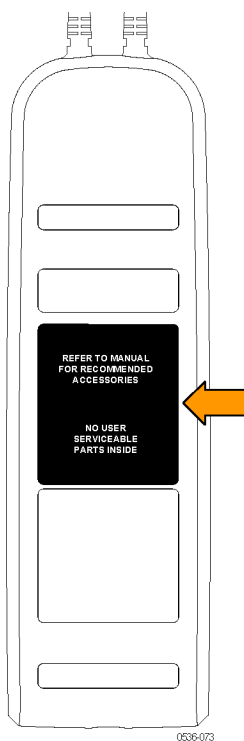

Options

Service Options

- **Option C3.** Calibration Service 3 years
- **Option C5.** Calibration Service 5 years
- **Option D1.** Calibration Data Report
- **Option D3.** Calibration Data Report, 3 years (with Option C3)
- **Option D5.** Calibration Data Report, 5 years (with Option C5)
- **Option R3.** Repair Service 3 years
- **Option R5.** Repair Service 5 years

Functional Check

Using accessories that are shipped with your probe and a source that supplies AC line voltage, perform the following procedure:



WARNING. To reduce risk of shock or fire, ensure that the accessories are fully mated before you connect to voltage sources above 42 Vpk.

1. Connect the output of the probe to the oscilloscope input channel.
2. Connect the probe inputs to the AC voltage source.
3. Connect the inputs, set the voltage range, and perform the check as each row of the following table indicates.

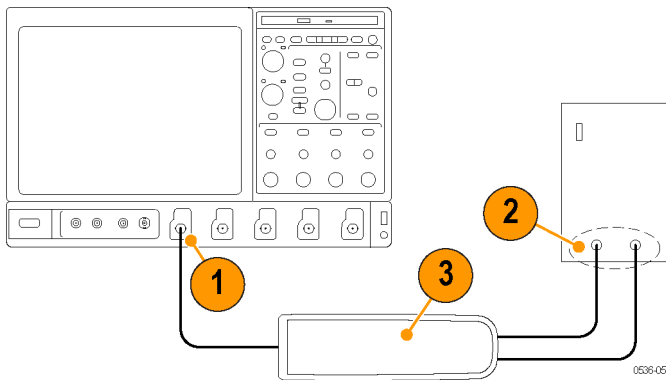

Figure 1: Functional check setup

Input 1 (+ or -)	Input 2 (- or +)	Mode	Range setting	Check
Hot	Ground or Neutral	Differential	High (6000 V, 1500 V, or 750 V)	Measurement instrument displays or indicates the line voltage
Hot	Ground or Neutral	Differential	Low (600 V, 150 V, or 75 V)	Measurement instrument displays or indicates the line voltage. Overrange indicator lights if the input is ~20% over
Hot	Hot (same connection)	Common Mode	High or low	No signal ¹

¹ If a DC offset voltage is present, zero the DC offset using the AutoZero function. (See page 20, *AutoZero*.)

AutoZero

The host instrument includes a feature that nulls the DC offset at the output of the probe. To initiate the AutoZero routine, do the following:

1. Allow the probe and oscilloscope to warm up for 20 minutes.
2. Press the MENU button on the probe to display the Probe Setup screen on the oscilloscope.



Figure 2: Probe Setup screen

3. Connect the probe inputs together with the hook tips.
4. Press AutoZero on the Probe Setup screen to initiate the AutoZero routine.

If the AutoZero routine does not yield sufficient results, use the *DC Offset Zero* procedure below.

DC Offset Zero

The offset stored through this feature is retained in the probe between probe power cycles. To set the probe DC offset to 0 V, do the following:

1. Set the oscilloscope offset for the probe channel to 0 volts.
2. Connect the probe inputs together with the hook tips.
3. Press and hold the probe BANDWIDTH LIMIT and RANGE buttons until the OVERRANGE LED on the probe begins flashing, and then quickly release the buttons (about 2 seconds).
4. Use the probe BANDWIDTH LIMIT or RANGE buttons to set the probe offset voltage to 0 V, as displayed on the oscilloscope. The BANDWIDTH LIMIT button decreases the offset voltage and the RANGE button increases it.
5. Press the AUDIBLE OVERRANGE button on the probe to store the value. The OVERRANGE LED on the probe stops flashing to confirm that the value has been stored.
6. Repeat steps 3 through 5 for the other range setting on the probe.

If you cannot null the offset with these steps, then use the *DC Offset Zero Reset* procedure that follows.

DC Offset Zero Reset

To reset the probe DC offset to the default values, do the following:

1. Connect the probe inputs together with the hook tips.
2. Press and hold the probe BANDWIDTH LIMIT and RANGE buttons until the OVERRANGE LED on the probe begins flashing.
3. When the OVERRANGE LED remains lit (after about 4 seconds), release the buttons.
4. Press the AUDIBLE OVERRANGE button on the probe to store the value. The OVERRANGE LED on the probe turns off to confirm that the default value for the DC offset has been stored.
5. Repeat steps 2 through 4 for the other range setting on the probe.
6. Perform the *DC Offset Zero* procedure as described in the previous section.

Operating Basics

To help you use the high voltage differential probes safely and effectively, this section provides important information about safety limits, operating characteristics, and probing techniques.

Operating Characteristics and Probing Techniques

This section explains the operating characteristics of the probes and includes techniques that you can use to maximize the performance of the probe.

Operating Limits

The probes have two operating ranges that you select with the RANGE button; the ranges differ between probe models.

To keep within the linear measurement region of the probe, select a range that is above the differential voltage that you are measuring. You can measure a voltage in the low range that exceeds the low range limit (provided it is within the high range limit of the probe), but it will overdrive the circuitry of the probe. When this differential overrange occurs, the probe detects the condition and lights the **OVERRANGE** indicator. Measurements taken in the lower, more sensitive range when the **OVERRANGE** indicator is lit are not accurate during the Overdrive Recovery Time (ORT, typically <20 ns, depending on the probe type).

Do not attempt to measure a differential voltage that is above the high operating range of the probe. (See Table 3.) Do not exceed the common mode voltage on either input (+ or – input to ground). (See Table 6 on page 27.) The probe can be damaged if these limits are exceeded.

Table 3: Differential voltage limits (peak)

Probe model	Low range		High range	
	Voltage limit	Overload trip level	Voltage limit	Overload trip level
THDP0100	600 V	>600 V	6000 V	>6000 V
THDP0200	150 V	>150 V	1500 V	>1500 V
TMDP0200	75 V	>75 V	750 V	>750 V

The input signals that you attempt to measure must be considered both for the differential potential between each other and for the amplitude on each input with respect to ground (the common mode voltage specification). The maximum common mode voltage limits vary between probes, from 550 V CAT I for the TMDP0200, to 2300 V CAT I for the THDP0100 probe. You should consider both specifications when choosing a probe for your measurement task. Some examples that illustrate this are shown on the following pages.

Measurement Examples

Example 1. Consider a case where you need to measure two sinusoidal waveforms that are 180° out of phase with each other, each with an amplitude of 1000 V_{pk} with no DC offset (centered at 0 V). (See Figure 3.)

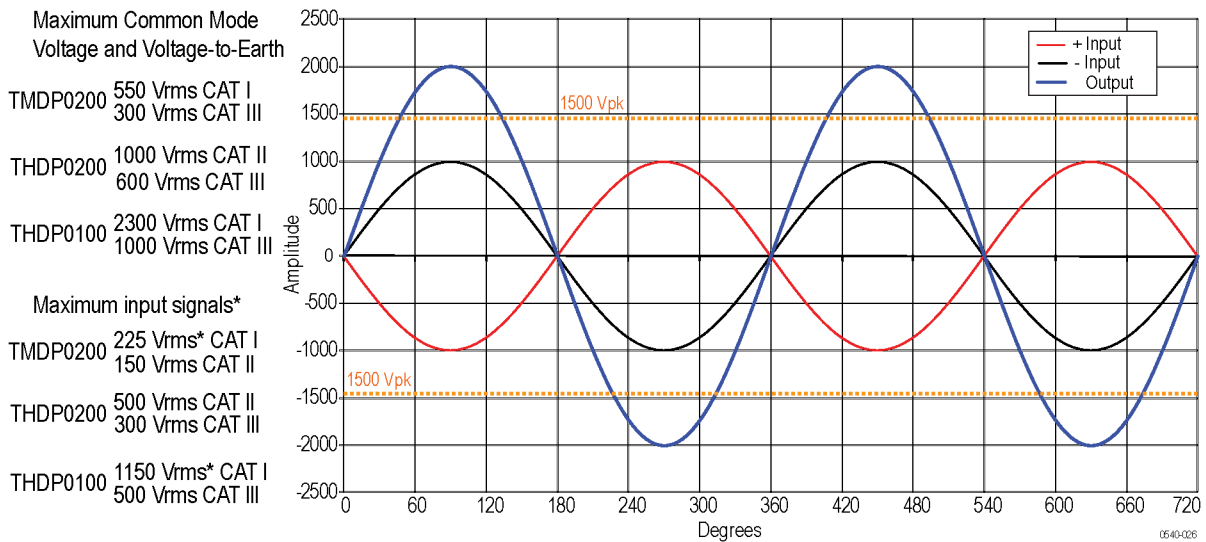

*Exceeding these voltages with sinusoidal waveforms of equal potential that are 180° degrees out of phase will exceed the maximum differential ratings and could result in a clipped waveform, measurement accuracy error, and increased risk of shock or fire.

Figure 3: Measuring two equal-amplitude waveforms that are 180 degrees out of phase

If both waveforms are at the same voltage potential, then the differential measurement would be 2 times the individual signal inputs (in this example, 2000 V_{pk}). Looking at the maximum measurable differential voltage specifications for the THDP/TMDP series probes, the THDP0100 probe is capable of measuring this signal. (See Table 6 on page 27.) For reference, the rms values of the Common-Mode Voltage and Voltage-to-Earth ratings and Maximum Input Signals for each probe model are shown in the figure above.

Example 2. Next, assume that the same waveforms from the previous example are 120° out of phase with each other. (See Figure 4.) This phase relationship yields a maximum differential of 1.732 times the individual signal inputs, or 1732 V_{pk}. Although this is a lower potential between the inputs than in example 1, it exceeds the differential voltage ratings of the THDP0200 and TMDP0200 probes, so you must use the THDP0100 probe.

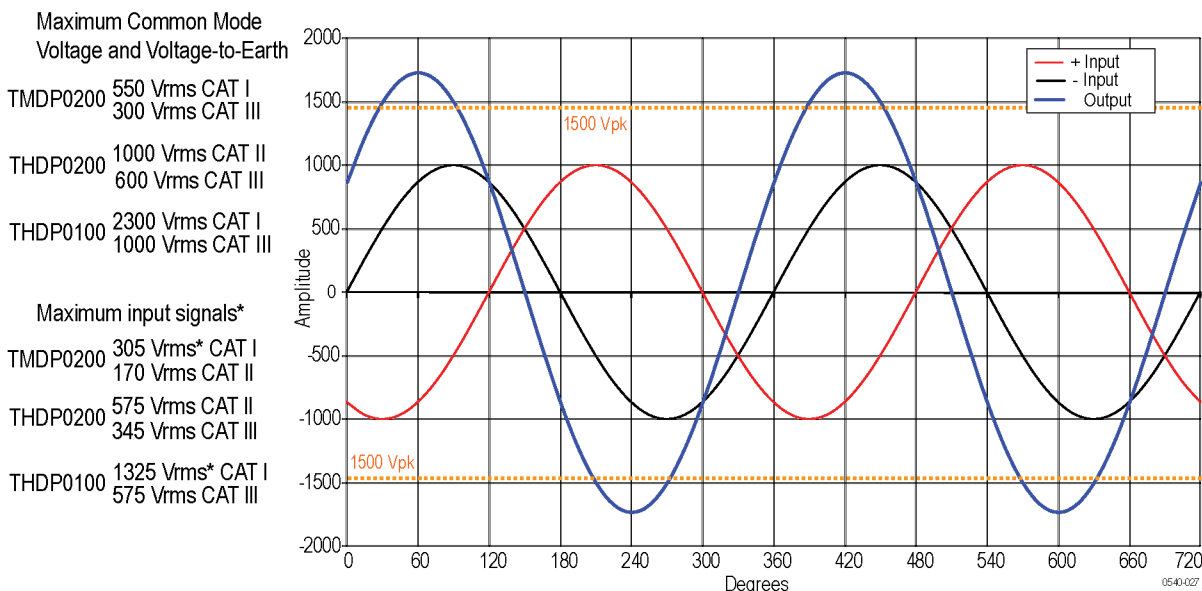

*Exceeding these voltages with sinusoidal waveforms of equal potential that are 120° degrees out of phase will exceed the maximum differential ratings and could result in a clipped waveform, measurement accuracy error, and increased risk of shock or fire.

Figure 4: Measuring two equal-amplitude waveforms that are 120 degrees out of phase

Example 3. Your task is to measure two AC waveforms of the same phase, each with an amplitude of 300 V. However, one waveform is centered on ground (– input), and the other is centered on an offset of 400 VDC (+ input). The common mode voltage is the 300 V_{rms}, but the maximum voltage-to-earth (the common mode voltage plus the signal waveform) must also be taken into account for both inputs. The voltage-to-earth is 300 V_{rms} on the (– input), but on the (+ input), the voltage-to-earth is 700 V_{rms} (the 300 VAC_{rms} plus the 400 VDC_{rms}). Thus the (+ input) exceeds the maximum input voltage-to-earth rating of the THDP0200 probe, so it cannot be used for taking this measurement. In this case, you must use either the TMDP0200 or THDP0100 probe.

Overrange Detection

Differential voltage outside the operating range will overdrive the circuitry of the probe and distort the output signal. When this differential overrange occurs, the probe detects the condition and lights the overrange indicator. With the Audible Overrange ON, the probe will also emit an audible alarm.



WARNING. *The Overrange indicator does not detect an overrange condition of common-mode voltages or voltage-to-earth potential at the probe inputs. The Overrange indicator only detects differentially between the + and – inputs (not relative to ground). Do not exceed the Common-Mode Voltage or Input Voltage-to-Earth ratings of the probe when taking measurements.*

If you are not sure, first take a single-ended measurement of each point that you are intending to measure differentially. Take a single-ended measurement by tying one input lead to ground (the – input) and then connecting the other lead (the + input) to the points of interest, one at a time.

Common-Mode Rejection

The common-mode rejection ratio (CMRR) is the specified ability of a probe to reject signals that are common to both inputs. More precisely, CMRR is the ratio of the differential gain to the common-mode gain. The higher the ratio, the greater the ability of probe to reject common-mode signals.

Common mode rejection decreases as the input frequency increases. For example, if you apply a 60 Hz line voltage of 500 V_{p-p} to both input leads of the probe, the probe rejects the signal by 80 dB (typical) and the signal appears as only a 50 mV_{p-p} signal on the oscilloscope screen.

Twisting the Input Leads

Twisting the input leads helps to cancel noise from high-EMI environments that is induced into the input leads.

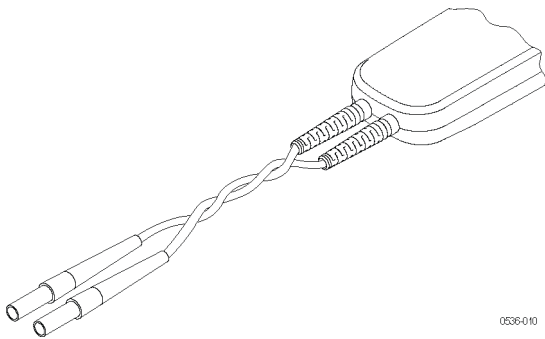

0536-010

Probe Loading

When you touch your probe tip to a circuit element, you are introducing a new resistance, capacitance, and inductance into the circuit. Frequency and impedance of the source determine how much the probe loads the circuit you are measuring. As the frequency of the source starts to increase beyond 1 kHz, the input impedance of the probe begins to decrease.

The lower the impedance of the probe relative to that of the source, the more the probe loads the circuit under test. For a graph of frequency versus input impedance, refer to the *Specifications* section. As the graph shows, the probes have virtually no loading effect on sources with relatively low impedance and low frequency.

Specifications

The specifications shown apply to the THDP/TMDP series probes installed on Tektronix MSO/DSO4000 oscilloscopes. When a probe is used with another oscilloscope, the oscilloscope must have an input impedance of 1 M Ω and a bandwidth equal to or greater than the probe. The probe must have a warm-up period of at least 20 minutes and be in an environment that does not exceed the limits described. (See Table 5.) Specifications for the THDP/TMDP series probes fall into three categories: warranted, typical and nominal characteristics.

Warranted Specifications

Warranted Specifications

Warranted characteristics describe guaranteed performance within tolerance limits or certain type-tested requirements. (See Table 5.)

Table 4: Warranted electrical specifications

Characteristics	THDP0100	THDP0200	TMDP0200
Rise time ¹ (small signal, 10–90%, +20 °C to +30 °C)	600 V: ≤ 3.6 ns (typical: ≤ 3.5 ns) 6000 V: ≤ 3.6 ns (typical: ≤ 3.5 ns) (slew rate ≥ 2500 V/ns (6000 V))	150 V: ≤ 2.4 ns (typical: ≤ 2.2 ns) 1500 V: ≤ 2.0 ns (typical: ≤ 1.8 ns) (slew rate ≥ 650 V/ns (1500 V))	75 V: ≤ 2.4 ns (typical: ≤ 2.2 ns) 750 V: ≤ 2.0 ns (typical: ≤ 1.8 ns) (slew rate ≥ 275 V/ns (750 V))
Gain accuracy	$\pm 2\%$	$\pm 2\%$	$\pm 2\%$

¹ Output may be slew rate limited for large amplitude signals.

Table 5: Warranted environmental specifications

Characteristics	THDP0100	THDP0200	TMDP0200
Temperature			
Operating		0 °C to 40 °C (32 °F to +104 °F)	
Nonoperating		–30° C to +70° C (–22 °F to +158 °F)	
Humidity			
Operating	5 to 85% RH (Relative Humidity) 0 °C to +40 °C (32 °F to +104 °F)		
Nonoperating	5% to 85% RH at up to +40° C (+104 °F) 5% to 45% RH above +40° C up to +70° C (+104 to +158 °F)		
Altitude			
Operating		3,000 m (9,842 ft)	
Nonoperating		15,240 m (50,000 ft)	

Typical Characteristics

Typical characteristics describe typical but not guaranteed performance.

Table 6: Typical electrical characteristics

Characteristics	THDP0100	THDP0200	TMDP0200
Maximum measurable differential voltage ¹	600 V Range: 600 V DC + peak AC 450 V _{rms}	150 V Range: 150 V DC + peak AC 100 V _{rms}	75 V Range: 75 V DC + peak AC 50 V _{rms}
	6000 V Range: 6000 V DC + peak AC 3000 V _{rms}	1500 V Range: 1500 V DC + peak AC 1000 V _{rms}	750 V Range: 750 V DC + peak AC 500 V _{rms}
Maximum common mode voltage and input voltage-to-earth ²	±6000 V DC + peak AC	±1500 V DC + peak AC	±750 V DC + peak AC
	2300 V CAT I	1000 V CAT II	550 V CAT I
	1000 V CAT III	600 V CAT III	300 V CAT III
CAT I Maximum Rated Over-Voltage Transient (OVT) ³	4600 V _{pk}	NA	3220 V _{pk}

¹ This is the maximum measurable range of the probe. Beyond these limits, the output could be clipped.

² The Common Mode ratings are the same as the input voltage-to-earth ratings (the maximum amount that each input lead (+/-) can be from ground).

³ Applies to CAT I ratings only (both ranges). The OVT peak is typically measured on top of the Peak Working Voltage.

Table 7: Typical electrical characteristics

Characteristics	THDP0100	THDP0200	TMDP0200
Bandwidth (-3 dB)	DC to ≥ 100 MHz	150 V: DC to ≥ 160 MHz 1500 V: DC to ≥ 200 MHz	75 V: DC to ≥ 160 MHz 750 V: DC to ≥ 200 MHz
Offset zero (+20 °C to +30 °C)	600 V: ± 1 V 6000 V: ± 10 V	150 V: ± 500 mV 1500 V: ± 5 V	75 V: ± 200 mV 750 V: ± 2 V
Input resistance			
Between inputs	40 M Ω $\pm 2\%$	10 M Ω $\pm 2\%$	5 M Ω $\pm 2\%$
Between each input and ground	20 M Ω $\pm 2\%$	5 M Ω $\pm 2\%$	2.5 M Ω $\pm 2\%$
Input capacitance			
Between inputs	<2.5 pF	<2.0 pF	<2.0 pF
Between each input and ground	<5.0 pF per side	<4.0 pF per side	<4.0 pF per side
Common Mode Rejection Ratio (20–30°C)	DC: >80 dB 100 kHz: >60 dB 3.2 MHz: >30 dB 100 MHz: >26 dB	DC: >80 dB 100 kHz: >60 dB 3.2 MHz: >30 dB 100 MHz: >26 dB	DC: >80 dB 100 kHz: >60 dB 3.2 MHz: >30 dB 100 MHz: >26 dB
Propagation delay	16 ns	14 ns	14 ns
DC offset drift (output referred)	50 μ V/ °C	50 μ V/ °C	50 μ V/ °C
Bandwidth limit filters	5 MHz	5 MHz	5 MHz
Input overdrive recovery	600 V: <30 ns to 10% of final value after 5X overdrive	150 V: <20 ns to 10% of final value after 5X overdrive	75 V: <20 ns to 10% of final value after 5X overdrive
Input referred noise (mV _{rms})	600 V: <175 mV 6000 V: <400 mV	150 V: <50 mV 1500 V: <140 mV	75 V: <25 mV 750 V: <65 mV

Mechanical Characteristics

Table 8: Typical mechanical characteristics

Characteristic	THDP0100	THDP0200	TMDP0200
Probe body dimensions	185 mm x 56 mm x 25 mm (7.3 in x 2.2 in x 1.0 in)		
Probe control box dimensions	76 mm x 31 mm x 41 mm (3.0 in x 1.2 in x 1.6 in)		
Input cable length	25.4 cm (10 in)		
Output cable length	1.5 m (59 in)		
Weight (probe only)	340 gm (12.0 oz)	309 gm (10.9 oz)	309 gm (10.9 oz)

Nominal Characteristics

Nominal characteristics describe guaranteed traits, but the traits do not have tolerance limits.

Table 9: Nominal electrical characteristics

Characteristics	THDP0100	THDP0200	TMDP0200
Number of inputs	Differential (two inputs, + and -)		
Input coupling	DC		
Output coupling	DC coupling		
Output termination	Terminate into 1 MΩ		
Attenuation	100X/1000X (600 V/6000 V)	50X/500X (150 V/1500 V)	25X/250X (75 V/750 V)
Differential overvoltage detection level ¹	600 V: >600 V 6000 V: >6000 V	150 V: >150 V 1500 V: >1500 V	75 V: >75 V 750 V: >750 V

¹ The Overrange/overvoltage indicator does not detect common mode voltage or voltage-to-earth potential at the probe inputs. To ensure that the common mode voltage or input voltage-to-earth ratings of the probe are not exceeded, the test points can be measured relative to ground by probing each separately with the + input lead while the - input lead is grounded (by taking a single-ended measurement).

Performance Graphs

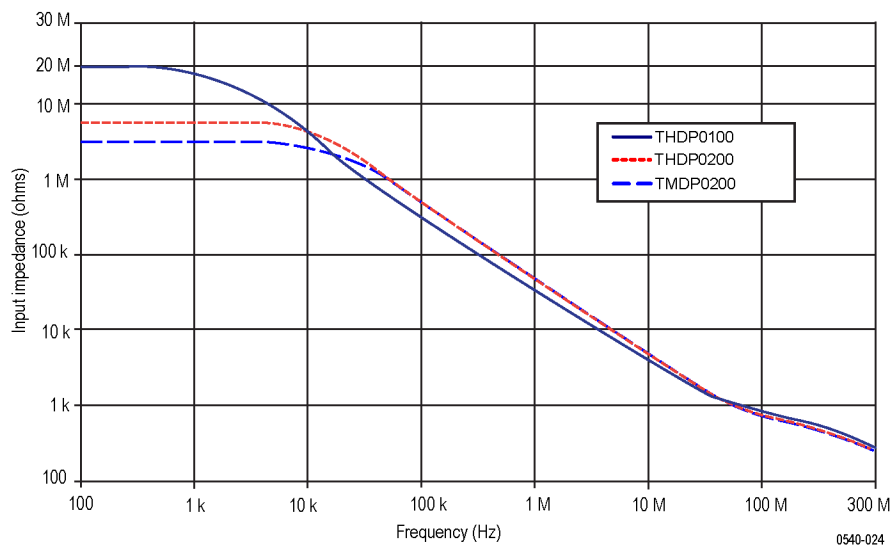

Figure 5: THDP0100/0200 and TMDP0200 impedance plots

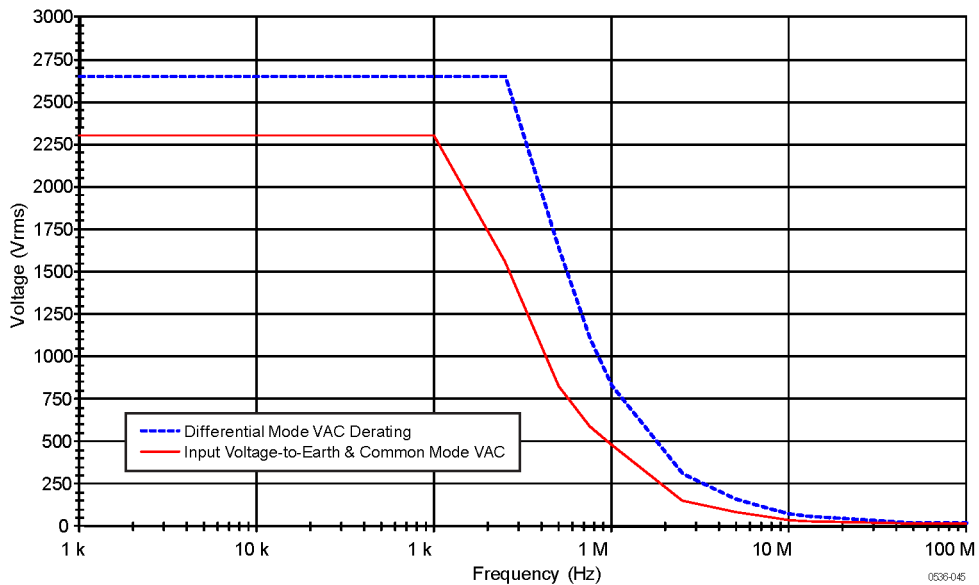

Figure 6: THDP0100 voltage derating curve

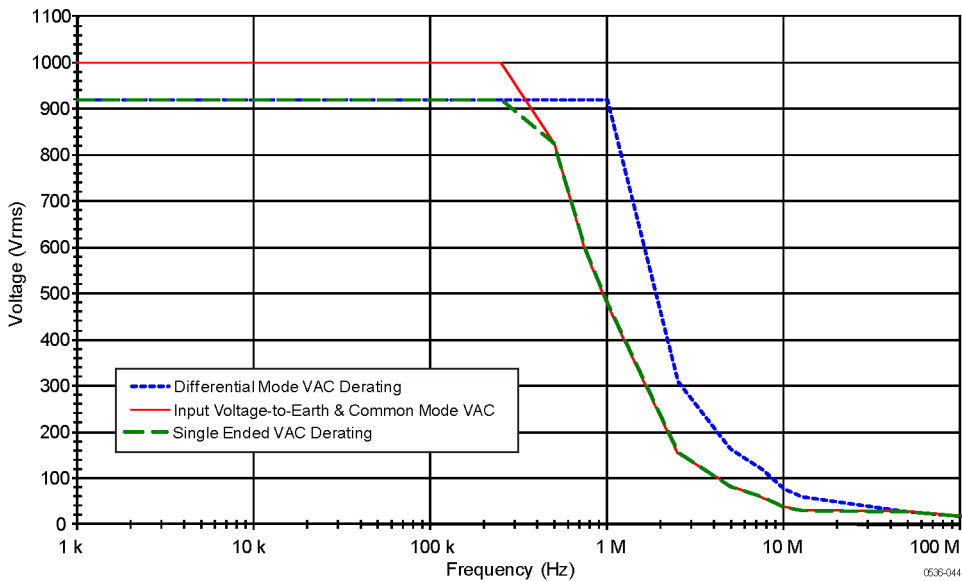

Figure 7: THDP0200 voltage derating curve

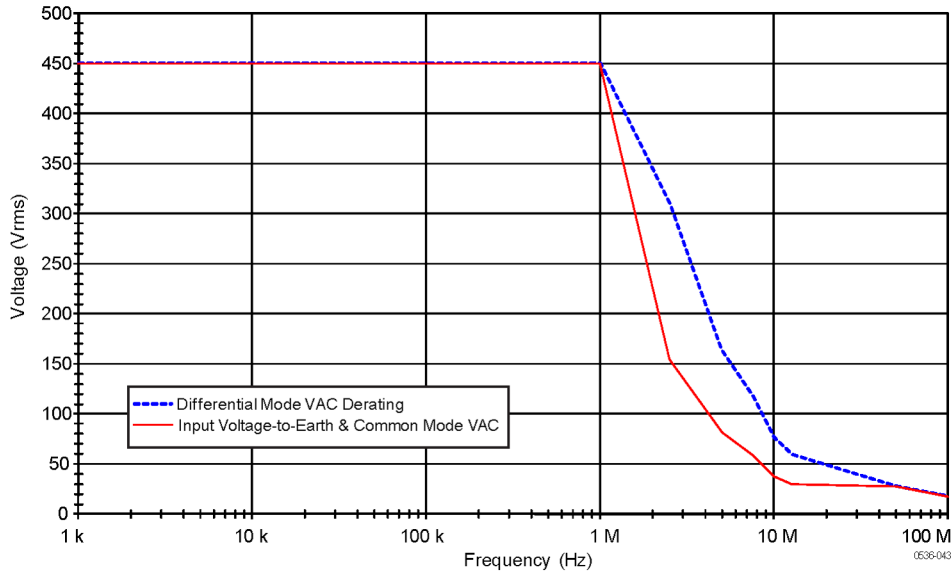

Figure 8: TMDP0200 voltage derating curve

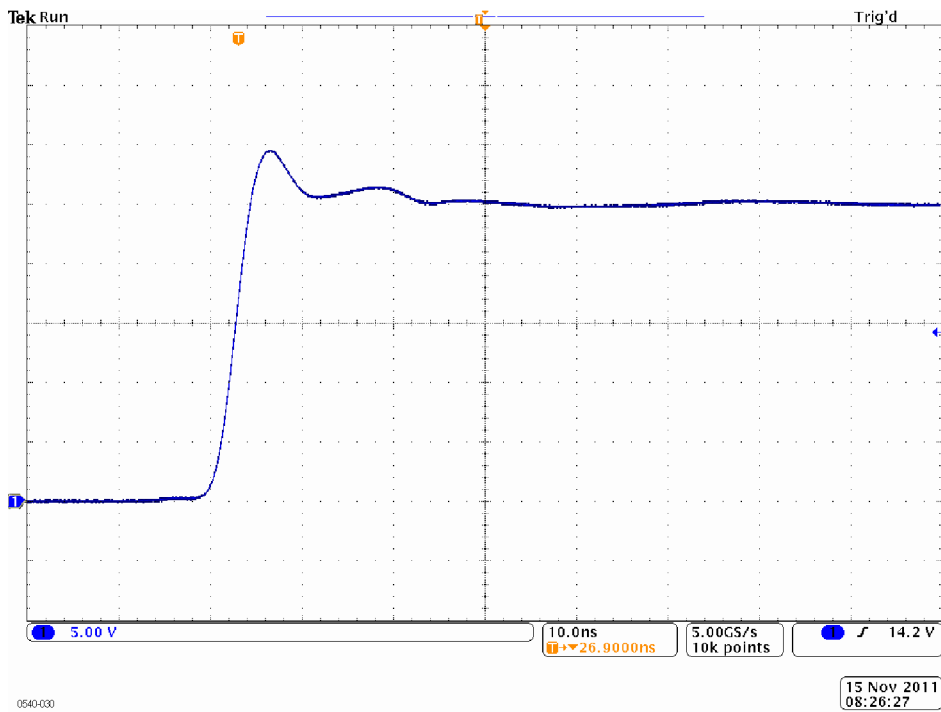

Figure 9: THDP0100 rise time (typical)

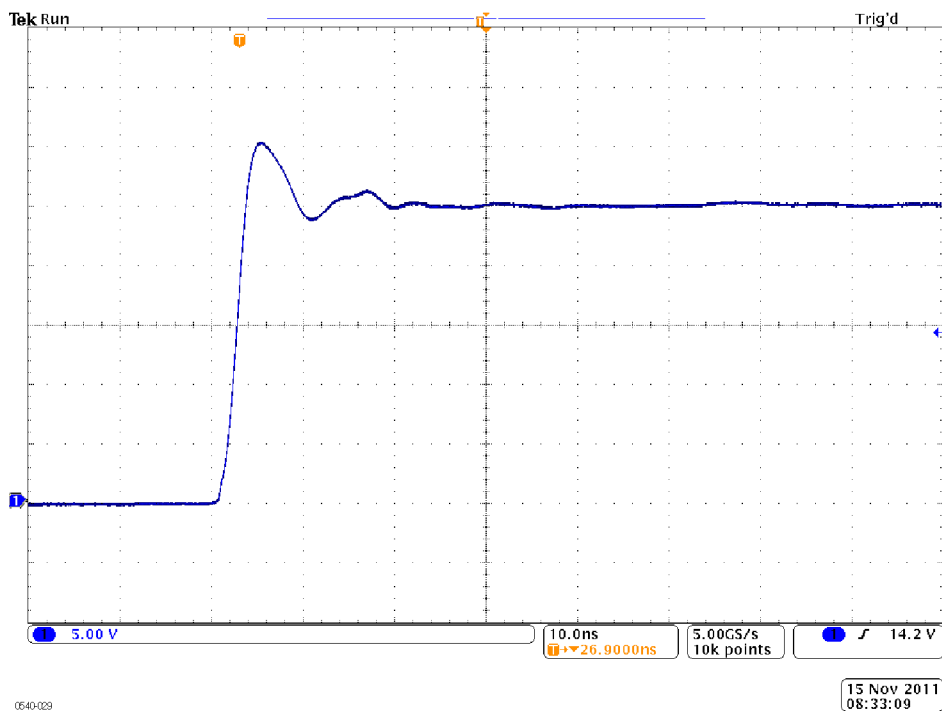

Figure 10: THDP0200 rise time (typical)

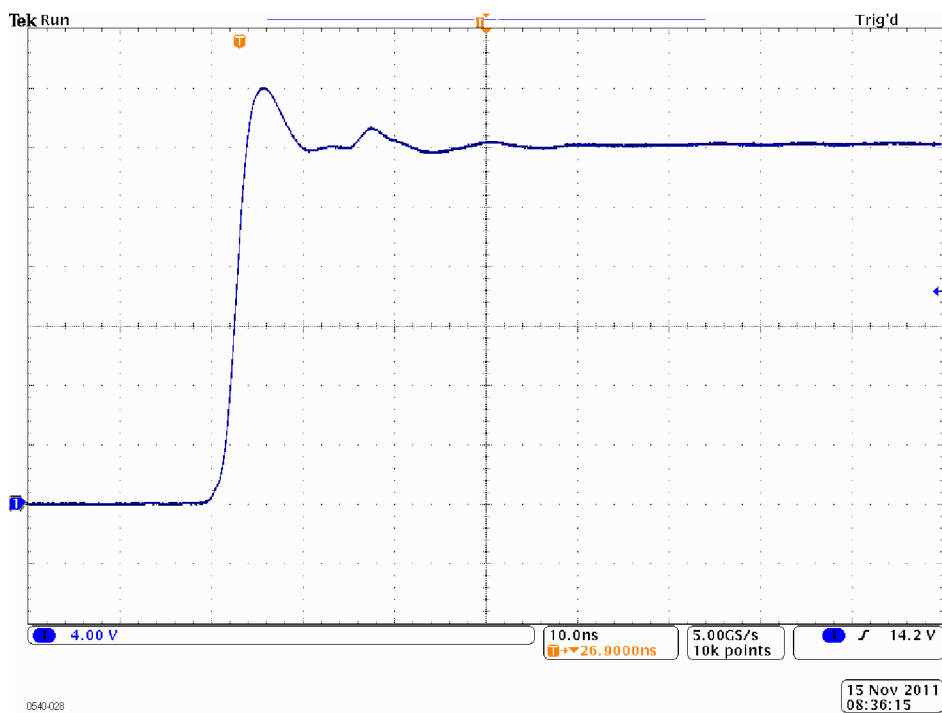

Figure 11: TMDP0200 rise time (typical)

Performance Verification

Use the following procedures to verify the warranted specifications of the probes. Before beginning these procedures, photocopy the test record and use it to record the performance test results. (See Table 13 on page 38.) The recommended calibration interval is one year.

These procedures test the following specifications:

- Gain accuracy
- Rise time

Required Equipment

The equipment required to perform the performance verification procedures are shown in the table below. The types and quantities of connectors may vary depending on the specific equipment you use.

Table 10: Equipment required

Description	Minimum requirements	Example product
Oscilloscope	500 MHz	Tektronix MSO/DSO4000
Generator	$\pm 100\text{V}$ variable amplitude, 100 Hz square wave, calibrated	Fluke 9100
Pulse generator	$\geq 50\text{ V}$, 200 ns pulse width, $\leq 500\text{ ps}$ rise time, 1 kHz	Avtech AVR-E2-B-W-P
Probe calibration fixture	TekVPI input (See Figure 12.)	Tektronix part number 067-1701-xx
Digital Multimeter (DMM)	100 mV and 1 V true RMS AC ranges, $\leq \pm 0.3\%$ accuracy	Tektronix DMM4040/4050
Cable	Coax, BNC, 50 Ω , 36 in	Tektronix part number 012-0482-xx
Adapter	BNC female-to-SMA male	Tektronix part number 015-1018-xx
Adapter	BNC female-to-dual banana female	Tektronix part number 103-0090-xx
Adapter	BNC female-to-female	Tektronix part number 103-0028-xx
Adapter	BNC male-to-dual banana male	Fluke PM9081
Termination	BNC feedthrough, 50 Ω	Tektronix part number 011-0049-xx
Attenuator	BNC, 50 Ω , 2X	Tektronix part number 011-0069-xx
Probe hook tips (2)	Included with probe accessory kit	Tektronix part number AC280-FL

TekVPI Calibration Fixture

This calibration fixture is required to complete a performance verification and gain accuracy adjustment procedures on the probes. It provides power to the probe and routes the probe output signal out through an SMA connector on the back of the fixture. The signal can then be measured with another instrument, such as a precision DMM, to check and adjust the gain accuracy of the probe. Order Tektronix part number 067-1701-xx.

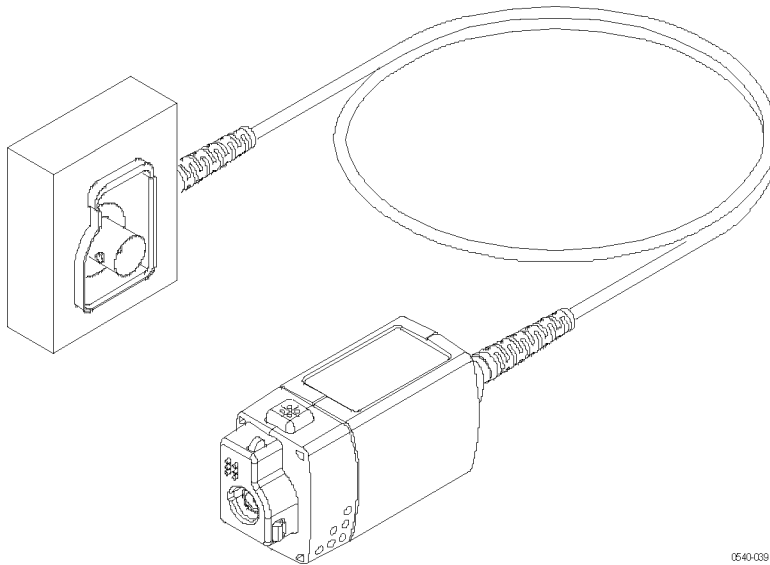

Figure 12: TekVPI calibration fixture

Test Procedures



WARNING. These procedures require the application of high voltage to the inputs of the probes. Only qualified personnel should perform any testing with voltage levels exceeding $30 V_{rms}$. All pertinent safety rules and guidelines for elevated voltage measurements should be followed and adhered to.

Test Setup

1. Turn on the oscilloscope.
2. Connect the probe to any channel of the oscilloscope.
3. Verify that the LEDs light on the probe.

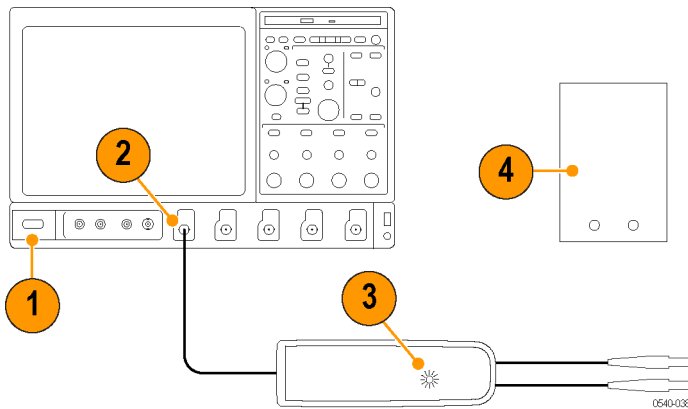

4. Turn on the remaining test equipment and let the probe and equipment warm up for 20 minutes.
5. Make a copy of the test record to tabulate the test results. (See Table 13 on page 38.)

Gain Accuracy



WARNING. Dangerous voltages will be present on the calibration generator output terminals and connection cables. Always verify that the generator is in the standby mode before you make any connections to the generator.

1. Verify that the generator output is off.
2. Connect the probe calibration fixture to any channel (1–4) on the oscilloscope.
3. Connect the probe output to the probe calibration fixture and the probe inputs to the generator.
4. Connect the output of the probe calibration fixture to the inputs of the DMM, using coax cables and adapters. Set the DMM to AC volts.

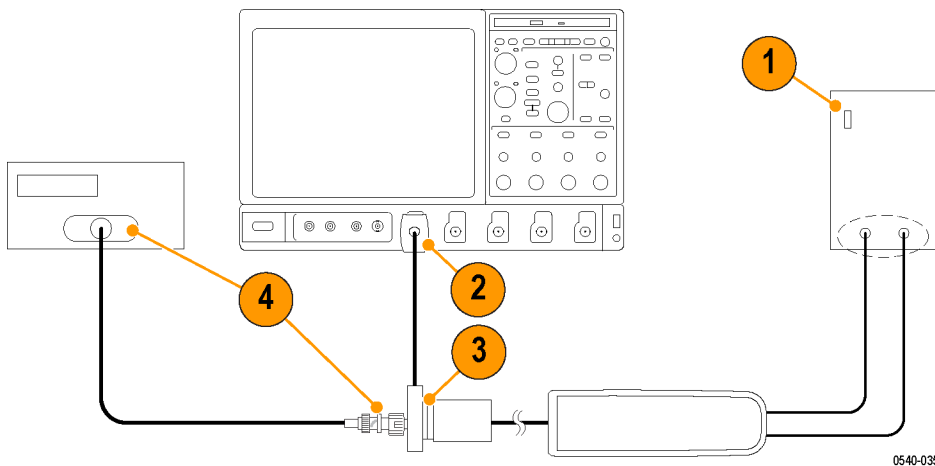

5. Set the probe attenuation to the lower range for the probe that you are testing. (See Table 11.)
6. Set the generator square wave output frequency and RMS voltage (main display) to the values shown in the table for the probe that you are testing.
7. Enable the generator output and record the probe output (as displayed on the DMM) in the test record.
8. Disable the generator output.
9. Set the probe attenuation to the next range and then repeat steps 6 through 8.

Table 11: Gain accuracy equipment settings

Model	Probe Range	Generator output		Probe output voltage	
		Voltage (rms)	Frequency	Expected (rms)	Measured (rms)
THDP0100	600 V	75 V	100 Hz	750 mV \pm 15 mV	
	6000 V	75 V	100 Hz	75 mV \pm 15 mV	
THDP0200	150 V	25 V	100 Hz	500 mV \pm 10 mV	
	1500 V	75 V	100 Hz	150 mV \pm 3 mV	
TMDP0200	75 V	20 V	100 Hz	800 mV \pm 16 mV	
	750 V	60 V	100 Hz	240 mV \pm 4.8 mV	

Rise Time

1. Verify that the pulse generator output is off and then connect the probe to the oscilloscope.
2. Connect the probe inputs, through the adapters shown below, to the pulse generator output. Set the probe input leads straight and parallel for best signal response.

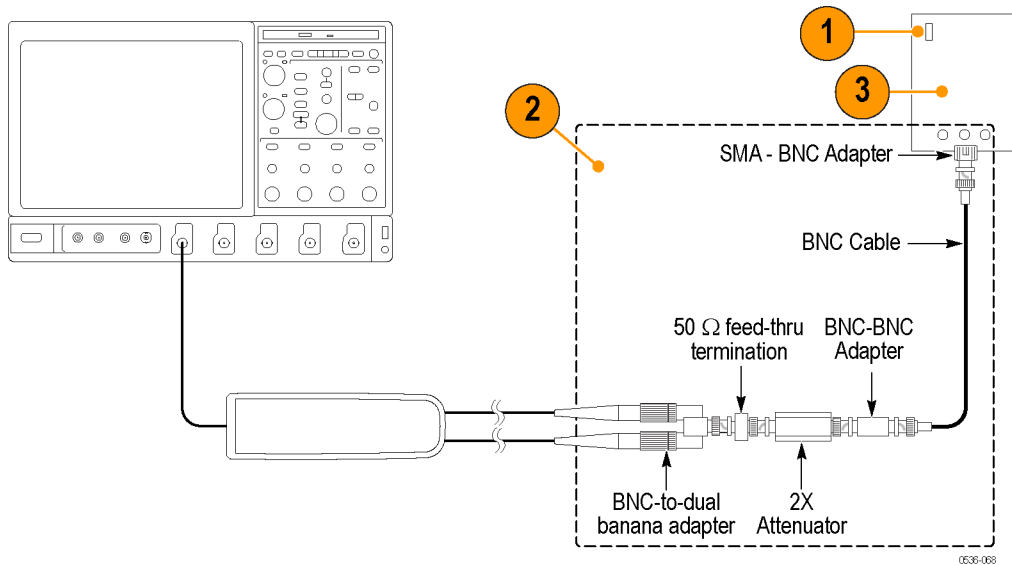

3. Set the output of the pulse generator to 50 V, 1 kHz, and a 200 ns pulse output. (The probe input voltage will be 25 V due to the 2X attenuator in the circuit.)
4. Set the oscilloscope to 5 V/div, 10 ns/div, BW = full, average = 16.
5. Set the probe bandwidth to full and the attenuation to the first range listed in the table.
6. Enable the generator output and check that the rise time does not exceed the target rise time value listed in the table. Use the auto-measure feature of the oscilloscope to determine the rise time.
7. Record the rise time in the test record.
8. Set the probe attenuation to the next range and adjust the vertical volts/div to display the signal.
9. Record the rise time in the test record and disable the generator output.

Table 12: Rise time test equipment settings

Model	Probe		Generator output		Measurement	
	Range	Voltage	Frequency	Target	Measured	
THDP0100	600 V	50 V	1 kHz	≤3.6 ns		
	6000 V	50 V	1 kHz	≤3.6 ns		
THDP0200	150 V	50 V	1 kHz	≤2.4 ns		
	1500 V	50 V	1 kHz	≤2.0 ns		
TMDP0200	75 V	50 V	1 kHz	≤2.4 ns		
	750 V	50 V	1 kHz	≤2.0 ns		

Test Record

Photocopy this test record for recording the results of the performance verification procedures.

Table 13: THDP & TMDP Series probes test record

Probe Model:

Certificate Number:

Probe Serial Number:

RH%:

Temperature:

Technician:

Date of Calibration:

Probe test	Range	Minimum	Incoming	Outgoing	Maximum
Gain accuracy					
THDP0100	600 V	735 mV			765 mV
	6000 V	73.5 mV			76.5 mV
THDP0200	150 V	490 mV			510 mV
	1500 V	147 mV			153 mV
TMDP0200	75 V	784 mV			816 mV
	750 V	235.2 mV			244.8 mV
Rise time					
THDP0100	600 V	—			3.6 ns
	6000 V	—			3.6 ns
THDP0200	150 V	—			2.4 ns
	1500 V	—			2.0 ns
TMDP0200	75 V	—			2.4 ns
	750 V	—			2.0 ns

Adjustments

Use the following procedures to make adjustments to the THDP & TMDP Series probes. (For probes with serial numbers C019999 and below, see note and table that follow.) These procedures describe how to make adjustments to the specifications listed below.

NOTE. Only probes with serial numbers C020000 and above have internal adjustments. (See Table 14.) Probes with serial numbers C019999 and below that require adjustments (other than offset zero) must be returned to Tektronix for service.

Table 14: THDP & TMDP Series probe adjustments

Specification	Adjustment method used	Probe serial number
Offset zero	External; user probe controls	All serial numbers
Gain accuracy	Internal; adjustments on PCB	Serial numbers C020000 and above
DC CMRR	Internal; adjustments on PCB	Serial numbers C020000 and above
LF compensation	Internal; adjustments on PCB	Serial numbers C020000 and above
AC CMRR	Internal; adjustments on PCB	Serial numbers C020000 and above

NOTE. The adjustments in the probes are preset at the factory for best overall performance. However, you may follow these procedures to check the probe characteristics and optimize them if necessary.



WARNING. These procedures require you to remove a reusable label from the back of the probe. You must replace the label after you complete the probe adjustments. Failure to do so may subject the user to high voltages present in the probe during measurements.

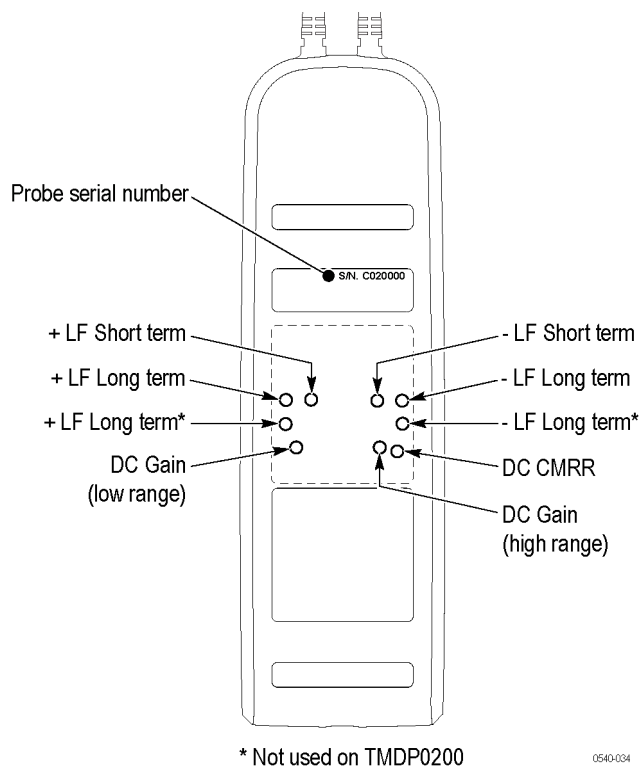

Figure 13: Probe serial number and adjustment locations

Equipment Required

The equipment required to perform the adjustment procedures are shown in the table below. The types and quantities of connectors may vary depending on the specific equipment you use.

Table 15: Equipment required for adjustments

Description	Minimum requirements	Example product
Oscilloscope	500 MHz	Tektronix MSO/DSO4000
Generator	± 100 V variable, 100 Hz square wave, calibrated	Fluke 9100
Probe calibration fixture	TekVPI inputs	Tektronix part number 067-1701-xx
Digital Multimeter (DMM)	100 mV and 1 V true RMS AC ranges, $< \pm 0.3$ % accuracy	Tektronix DMM4040/4050
Cable	Coax, BNC, 50 Ω , 36 in	Tektronix part number 012-0482-xx
Adapter	BNC female-to-SMA male	Tektronix part number 015-1018-xx
Adapter	BNC male-to-dual binding post	Tektronix part number 103-0035-xx
Adapter	BNC male-to-dual banana male	Fluke PM9081
Probe hook tips (2)	Included with probe accessory kit	Tektronix part number AC280-FL
Adjustment tool	Insulated, slotted (straight) head	Tektronix part number 003-1433-xx
Adjustment tool ¹	Insulated, narrow-slotted (straight) head	Tektronix part number 003-1928-xx
Replacement rear-panel label ^{2 3}	Reusable, adhesive-backed label that covers adjustment access openings	Tektronix part number 335-2913-xx

¹ Required for the CMRR adjustment

² The original label is backed with a reusable adhesive. If the label does not sufficiently adhere to the probe, order a replacement.

³ Label removal is not required to access offset zero adjustments

Adjustment Procedures



WARNING. These procedures require the application of high voltage to the inputs of the probes. Only qualified personnel should perform any testing with voltage levels exceeding 30 V_{rms}. All pertinent safety rules and guidelines for elevated voltage measurements should be followed and adhered to.

Test Setup

1. Turn on the oscilloscope.
2. Connect the probe to any channel of the oscilloscope.
3. Verify that the LEDs light on the probe.

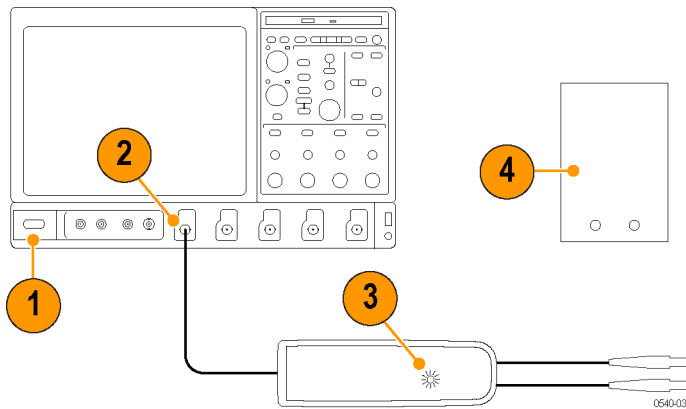

4. Turn on the remaining test equipment and let the probe and equipment warm up for 20 minutes.

Offset Zero

This is the only procedure that applies to all of the probes and all serial numbers.

Adjustment notes.

- For probes with serial numbers C199999 and below, Offset Zero is the only adjustment that can be done to the probe.
- For probes with serial numbers C020000 and above, Offset Zero is the only adjustment that can be done without removing the back label.
- The adjustment for each range is independent and does not interact between the ranges.

Procedure.

1. Set the oscilloscope offset to 0 volts.
2. Connect the probe inputs together with the hook tips.

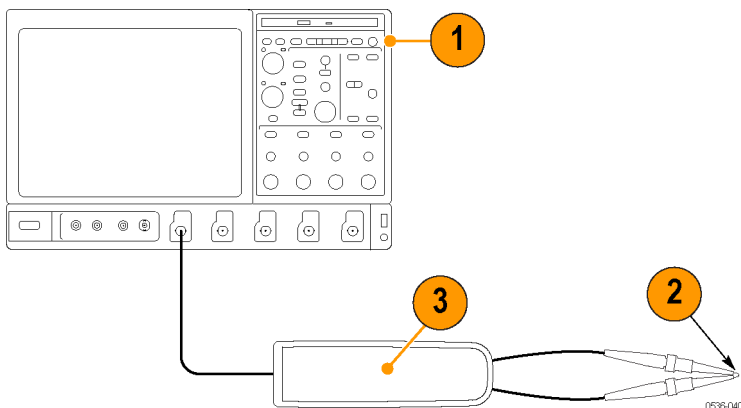

3. Press and hold the probe BANDWIDTH LIMIT and RANGE buttons until the OVERRANGE LED on the probe flashes.
4. Release the buttons. The OVERRANGE LED continues to flash, indicating that the digitally-controlled offset zero adjustment is enabled.
5. Use the probe BANDWIDTH LIMIT and RANGE buttons to set the probe offset voltage as close to 0 V as possible, as displayed on the oscilloscope. The BANDWIDTH LIMIT button decreases the offset voltage and the RANGE button increases it.
6. Press the AUDIBLE OVERRANGE button on the probe to store the adjusted offset value. The OVERRANGE LED stops flashing to indicate that the offset value is stored and that the adjustment is disabled.
7. Select the remaining attenuation range and repeat steps 3 through 6.

Accessing the Internal Adjustments

NOTE. Only probes with serial numbers C020000 and above have internal adjustments. (See Figure 14.) Probes with serial numbers C019999 and below that require adjustments (other than offset zero) must be returned to Tektronix for service.



WARNING. The remaining adjustments for the probe require you to remove a reusable label from the back of the probe. You must replace the label after you complete the probe adjustments. Failure to do so may subject the user to high voltages present in the probe during measurements. If you need a replacement label, refer to the Equipment Required table for the Tektronix part number. (See Table 15 on page 41.)

1. Remove the reusable back-panel label shown below to gain access to the adjustments. Store the label in a safe place to preserve the adhesive backing for reuse.

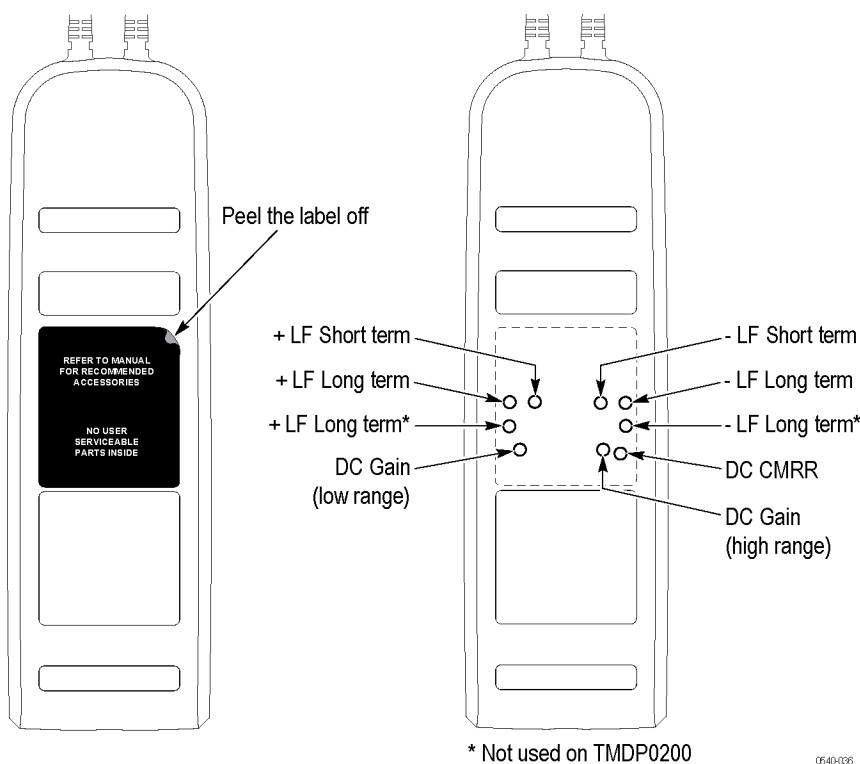

Figure 14: Internal adjustment locations (S/N C020000 and above only)



CAUTION. You must replace the reusable label after you complete the adjustment procedures. Failure to do so may subject the user to high voltages present in the probe during measurements. If you need a replacement label, refer to the Equipment Required table for the Tektronix replacement part number. (See Table 15 on page 41.)

9. Enable the generator output.
10. Adjust the low-range DC gain pot in the probe to $\leq 2\%$ of the expected output.



WARNING. Use only an insulated tool to make the adjustment. Failure to do so presents a potential shock hazard.

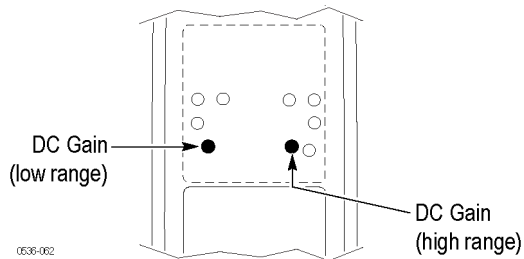

11. Disable the generator output.
12. Set the probe attenuation to the next range and set the generator output voltage to the value shown in the table.
13. Enable the generator output and adjust the high-range DC gain pot in the probe to $\leq 2\%$ of the expected output.
14. Disable the generator output.

DC CMRR



WARNING. Dangerous voltages will be present on the calibration generator output terminals and connection cables. Always verify that the generator is in the standby mode before you make any connections to the generator.

1. Verify that the generator output is off.
2. Connect both of the probe inputs to the red (+) banana connector on the front output terminals of the generator. Use a BNC-banana adapter if necessary.

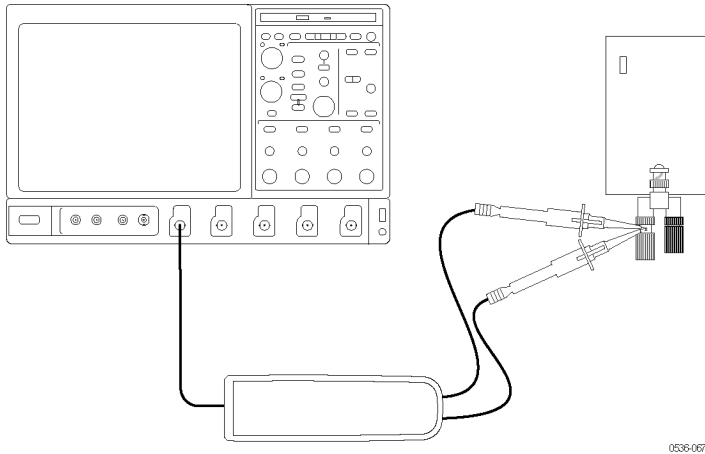

0536-067

3. Set the output of the generator to the voltage and frequency listed in the table. (See Table 17.)

Table 17: DC CMRR test equipment settings

Model	Probe		Generator output	
	Range	Voltage (rms)	Voltage (p-p)	Frequency
THDP0100	600 V	353.53 V	1000 V	40 Hz
THDP0200	150 V	200 V	566 V	40 Hz
TMDP0200	75 V	353.53 V	1000 V	40 Hz

4. Set the oscilloscope horizontal to 10 ms/div and bandwidth to 5 MHz.
5. Set the probe attenuation to the lower (most sensitive) range of the probe.
6. Enable the generator output. Set the oscilloscope vertical to display the signal. For a stable display, connect the generator Sense output to another channel and trigger off of that channel.

- Using the narrow-bladed tool, adjust the DC CMRR pot in the probe to minimize the amplitude of the waveform displayed on the oscilloscope. Use averaging or hi-res filters to make viewing the 40 Hz signal easier.



WARNING. Use only an insulated tool to make the adjustment. Failure to do so presents a potential shock hazard.

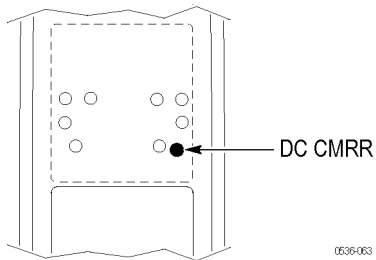

- Disable the generator output.

LF Compensation



WARNING. Dangerous voltages will be present on the calibration generator output terminals and connection cables. Always verify that the generator is in the standby mode before you make any connections to the generator.

NOTE. The TMDP0200 probe only has one long-term +LF adjustment and one long-term –LF adjustment. The other two probe models have two long-term +LF adjustments and two long-term –LF adjustments each.

1. Verify that the generator output is off.
2. Connect the probe inputs to the signal output connector on the back of the generator, using adapters if necessary. Connect the red probe lead to the signal, and the black lead to ground.

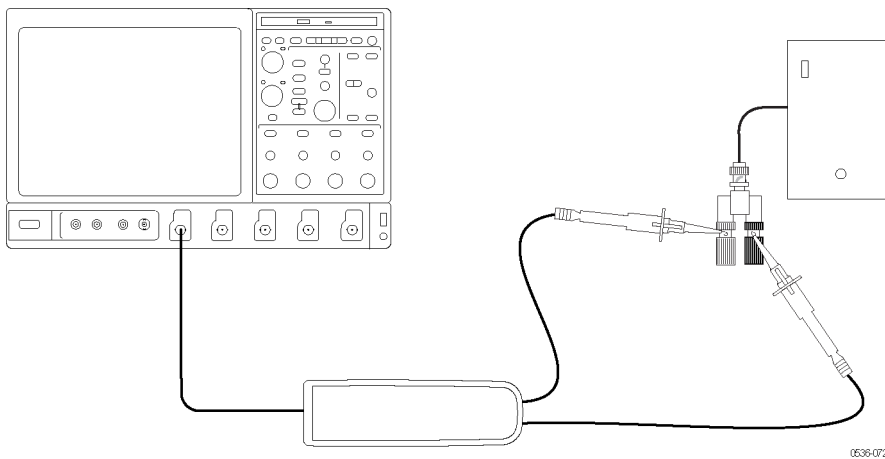

3. Set the probe attenuation to the lower range for the probe that you are adjusting.
4. Set the oscilloscope horizontal to 4 $\mu\text{s}/\text{div}$, acq mode = average 16.
5. Set the generator fast-rise (rise time waveform) output frequency to 10 kHz.
6. Set the generator fast-rise output voltage to 50 V_{p-p} .

Table 18: LF compensation test equipment settings

Model	Probe		Generator output	
	Range	Voltage (p-p)	Frequency	
THDP0100	600 V	50 V	10 kHz	
THDP0200	150 V	50 V	10 kHz	
TMDP0200	75 V	50 V	10 kHz	

7. Enable the generator output. Set the oscilloscope vertical to display the signal.

8. Make the adjustments in the following order: long-term +LF, long-term +LF*, short-term +LF. (The long-term +LF* adjustment is not used in the TMDP0200 probe.) Repeat this sequence as necessary to optimize the square-wave response.



WARNING. Use only an insulated tool to make the adjustment. Failure to do so presents a potential shock hazard.

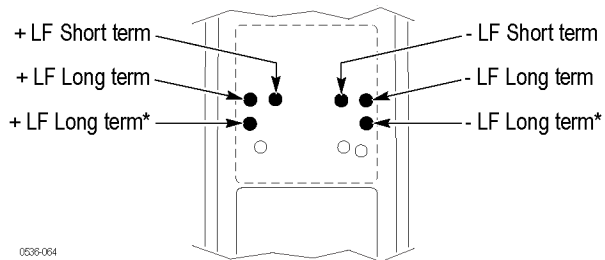

9. Disable the generator output.
10. Reverse the probe input leads to the generator.
11. Invert the signal and trigger slope on the oscilloscope to display the rising edge of the signal. Adjust the trigger level if necessary.
12. Enable the generator output and make the adjustments in the following order: long-term -LF, long-term -LF*, short-term -LF. (The long-term -LF* adjustment is not used in the TMDP0200 probe.) Repeat this sequence as necessary to optimize the square-wave response.

AC CMRR



WARNING. Dangerous voltages will be present on the calibration generator output terminals and connection cables. Always verify that the generator is in the standby mode before you make any connections to the generator.

1. Verify that the generator output is off.
2. Connect both of the probe inputs to the red (+) banana connector on the front output of the generator. Use a BNC-banana adapter if necessary.

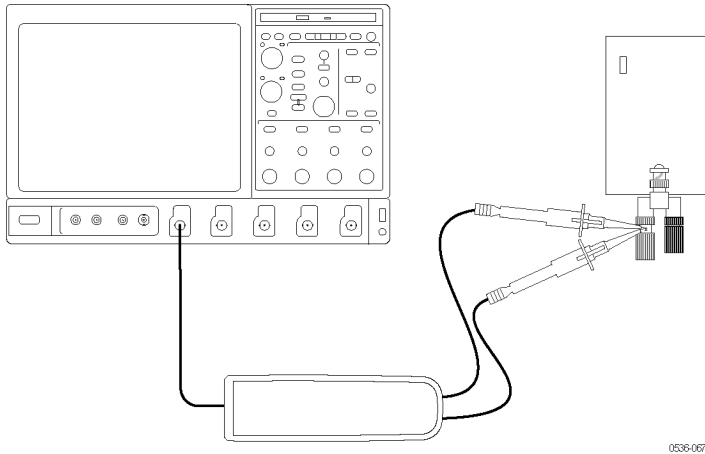

3. Set the output of the generator to 297 V_{p-p} (105 V_{rms}) @100 kHz.

Table 19: AC CMRR test equipment settings

Model	Probe	Generator output	
	Range	Voltage (p-p)	Frequency
THDP0100	600 V	297 V	100 kHz
THDP0200	150 V	297 V	100 kHz
TMDP0200	75 V	297 V	100 kHz

4. Set the oscilloscope horizontal to 10 μ s/div.
5. Set the probe bandwidth to full and the attenuation to the lower range of the probe.
6. Enable the generator output. Adjust the oscilloscope vertical to display the signal.

7. Make only slight adjustments to only the +LF pots to optimize the CMRR (minimize the signal amplitude). Adjust the pots in the following order: short-term +LF, long-term +LF, long-term +LF*. (The long-term +LF* adjustment is not used in the TMDP0200 probe.)



WARNING. Use only an insulated tool to make the adjustment. Failure to do so presents a potential shock hazard.

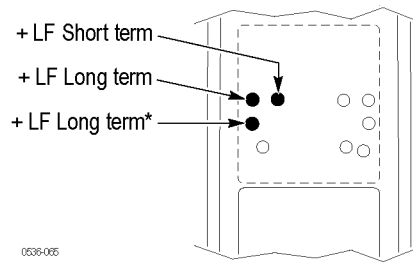

This completes the adjustment procedures.

Troubleshooting

Host Instrument Firmware

Some instruments may require a firmware upgrade to support full functionality of the latest probes that are offered by Tektronix. Instruments with lower versions of firmware may not display all probe controls and indicators on screen, and in some cases may require you to power-cycle the instrument to restore normal instrument operation. If you are having problems with your probe and suspect that you need to upgrade your instrument firmware, go to www.tektronix.com/probe-support to download the latest firmware.

To check the firmware version on Windows-based instruments, from the menu bar, click Help/About TekScope. On Linux-based instruments, press the Utilities button on the front panel.

Error Conditions

LEDs Do Not Remain Lit

If none of the LEDs remain lit after you connect the probe, a probe/oscilloscope interface fault may exist. Perform the following steps until you clear the fault or isolate the problem:

- Disconnect and reconnect the probe to restart the power-on diagnostic sequence.
- Connect the probe to a different channel on the oscilloscope.
- Disconnect the probe from the oscilloscope, power-cycle the oscilloscope, and then reconnect the probe.
- Connect the probe to a different oscilloscope.

If the symptoms remain (they follow the probe), then the probe is defective and must be returned to Tektronix for repair.

Signal Display

If the probe is connected to an active signal source and you do not see the signal displayed on the oscilloscope:

- Check that the probe accessories that you are using are fully mated.
- Check the probe connection on your circuit.
- Perform a functional check on the probe.

Cleaning

Protect the probe from adverse weather conditions. The probe is not waterproof.



CAUTION. *To prevent damage to the probe, do not expose it to sprays, liquids, or solvents. Avoid getting moisture inside the probe when cleaning the exterior.*

Clean the exterior surfaces of the probe with a dry, lint-free cloth or a soft-bristle brush. If dirt remains, use a soft cloth or swab dampened with a 75% isopropyl alcohol solution. Use only enough solution to dampen the cloth or swab. Do not use abrasive compounds on any part of the probe.

Service

There are no user-serviceable parts in the probes. If your probe requires service, contact your Tektronix service representative or repair center for instructions on returning your probe for repair.

Index

A

- Accessories
 - optional, 17
 - THDP0100 standard, 6
 - THDP0200 standard, 10
 - TMDP0200 standard, 10
- Adjustments (service), 39
- Audible overrange, 5
- AutoZero, 20

B

- Bandwidth limit, 5

C

- Cleaning, 54
- Common-mode rejection, 25
- Connecting to the circuit, 2
- Connecting to the instrument, 1

D

- DC offset zero, 21
- DC offset zero reset, 21

E

- Error conditions
 - LEDs, 53
 - signal display, 53

F

- Firmware, 53

- Functional check, 19

H

- Host instrument firmware, 53

L

- Loading, 25

M

- Measurement examples, 23

O

- Operating basics, 22
- Operating limits, 22
- Optional accessories, 17
- Overrange, 4, 5
- Overrange detection, 25

P

- Performance graphs, 29
- Performance verification, 33
 - test record, 38
- Probe controls
 - Audible overrange, 5
 - Bandwidth limit, 5
 - Menu button, 3
 - Overrange indicator, 4
 - Probe release button, 3
 - Range, 5
 - Status indicator, 3

- Probe controls and indicators, 3
- Probe inputs, 4
- Probe loading, 25
- Probe release button, 3
- Probe setup screen, 20
- Probing techniques, 22

R

- Range, 5

S

- Service, 54
- Service options, 18
- Specifications, 26
 - mechanical, 28
 - nominal, 29
 - typical, 27
 - warranted, 26

T

- TekVPI calibration fixture, 34
- Test record, 38
- Troubleshooting, 53